

HONGKONG
Suite 6409, 64/F, Central Plaza, 18 Harbour Road, Wanchai, Hong Kong
Tel: 852-29681113 Fax:852-29681080

CHONGQING
No.72, Avenue Of Stars, Innovative & High-Tech Park, Northern New District, Chongqing, China
Tel: 86-23-61867777 Fax:86-23-61867775

Water Nurtures All 2020

Environmental, Social and
Governance Report

Kangda International Environ-
mental Company Limited



CONTENTS

01-02
About This Report

03-04
Management's Statement

05-10
About Kangda International

Company Profile
Business Overview
Key Performance

11-18
Sustainability Management

Corporate Governance
ESG Management
Materiality Analysis
Operation with Integrity

19-32
Shared Development

Quality Upgrade
Innovation and R&D
Responsible Supply
Industry Contribution

33-44
Talent Development

Employee Employment
Talent Development
Health and Safety
Employee Care

45-52
Environmental Protection

Green Management
Low Carbon and Consumption Reduction
Compliance Emissions

53-60
Community Engagement

"Green" Co-construction
Philanthropy

61-64
Appendix

Content Index of the Environmental, Social and Governance Reporting Guide of the Hong Kong Stock Exchange



ABOUT THIS REPORT

Overview and Principles

This is the fifth Environmental, Social and Governance ("ESG") report of Kangda International Environmental Co., Ltd. ("Kangda International" "Company" or "We"), which is compiled in accordance with the rules in the Appendix 27 of the Guidelines for Environmental, Social and Governance Reporting ("ESG Reporting Guidelines") of the rules governing the listing of securities on The Stock Exchange of Hong Kong Limited ("HKSE") ("Listing Rules"), covering the company's performance and data in the areas of business development, environmental protection, employee caring, and community investment from January 1 to December 31, 2020.

Report scope

The policies, statements, materials and data in this report cover the urban water projects, water environment comprehensive management and rural sewage treatment projects that the company and its subsidiaries have major involvement. Unless otherwise stated, all currencies in this report refer to CNY.

The report follows the principles of "materiality", "quantification", "balance" and "consistency" of the ESG Reporting Guidelines of HKSE. The content of the report is derived mainly from the assessment and analysis of major issues and the opinions of the stakeholders. Please refer to the chapter "ESG Management" for detailed procedures.

Confirmation and approval

The content of this report has been confirmed by the management and directors.

This report is available in simplified Chinese, traditional Chinese and English. The digital version of the report is available on the website of HKSE in the category of "Financial Statements/ESG Information" and it can also be obtained from the Company's website. If you have any questions or comments on this report, please send them to us in the following ways:

Address: No.72, Avenue Of Stars, Innovative & High Tech ark, Northern New District, Chongqing, China

Phone: +86-23 6186 7777

Fax: +86-23 6186 7775

Email address: kangda@kangdaep.com

Official website: www.kangdaep.com

MANAGEMENT'S STATEMENT



"Water gives life to the ten thousand things and does not strive. It flows in places men reject and so is like the Tao. In dwelling, be close to the land. In meditation, go deep in the heart. In dealing with others, be gentle and kind. In speech, be true. In ruling, be just. In business, be competent. In action, be timely." This is Lao Tzu's interpretation of "water". Since its establishment, Kangda International has insisted on taking "water" as the carrier to contribute its part to the world and disseminate virtue through water governance, and is committed to realizing the corporate vision of "leading the environmental protection industry and standing for a hundred years".

Environmental protection. With the deepening of the green development concept and the proposal of "peak emission" and "carbon neutral" goals in China, Kangda International - as an environmental protection

investment and operation company - adheres to the corporate mission of "making water clearer, mountains greener, and skies bluer" and actively explores new technologies and new channels to control environmental pollution. Focusing on the three business sectors of urban water treatment, water environment comprehensive remediation and rural sewage treatment, the Company takes advantage of the transformation and reform of the environmental industry, strives to explore the new ecology of the environmental industry, and spares no effort to promote eco-environmental development with professional technology and high-quality services. Moreover, we always fulfill our corporate responsibilities. While creating clear waters and green mountains for the society, we reduce the environmental impact of our own operations through energy conservation, consumption reduction, pollution and emission reduction, and create a new model of sustainable development for a better living environment.



Shared development. Kangda International actively builds a win-win industrial ecology. Internally, we insist on "consolidating the foundation of operation and management and pooling efforts to tackle difficulties in the water industry", implement the quality-oriented development strategy, continuously improve the quality management level of project construction and operation, and refine product quality based on innovation and R&D. Externally, we actively carry out industry-university-research cooperation, work with all parties to promote industrial upgrading and progress, and contribute more to the improvement of water environment quality and the construction of ecological civilization.



Talent development. Kangda International is committed to building a healthy, harmonious and equal employee employment system. We improve the employee training system, optimize the employee development system, and enrich the professional knowledge and job skills of employees, so that every employee can have the opportunity to learn and progress. We actively promote employees to participate in the Company's development, so that employee well-being and corporate profitability grow together. We also pay attention to ensuring the health and safety of employees, and provide all employees with a safe and comfortable working environment.

Community engagement. Kangda International practices its core values of "integrity and responsibility, and give back to society" and takes practical actions to promote social development. We are committed to education promotion, community care, fight against the epidemic, and other charitable activities, and join hands with all walks of life to participate in charity, so as to contribute love and warmth to social progress. We are also committed to strengthening communication with the community, building a beautiful home together, and raising the public's attention to environmental protection through projects such as charitable environmental protection education and environmental protection activities.

"Stick to the front line to fight the epidemic and protect people's livelihood with sewage treatment." Looking back on the raging Covid-19 epidemic in 2020, Kangda International, as the backbone of the environmental protection industry, always abode by the professional ethics of environmentalists, guaranteed the smooth operation of people's livelihood projects, and protected the health and safety of employees and residents.

As a line of a famous Chinese poem goes, "Not only is this flowing water surging, but it will (along with many flowing waters) converge in the vast ocean, contributing its part to the magnificent waves." Looking into the future, Kangda Environmental will seize the opportunities provided by national policies, continue to focus on the development of the main business of municipal sewage treatment, deepen the Company's refined management of production and operation, and continue to promote sustainable social development while seeking own development, so as to create higher value for shareholders, customers, and society and contribute to the healthy development of society and business environment!

ABOUT KANGDA INTERNATIONAL



1.1 Company Profile

Kangda International Environmental Co., Ltd. is listed on the stock exchange of Hong Kong (Stock Code: 6136). The Company is an environmental protection service provider specialized in environmental pollution control, urban sewage treatment, and solid waste treatment projects. With BOT, TOT, EPC, PPP and other business models, we provide comprehensive water project solutions and services for customers through investment, construction and operation, and technical services in capital operation.

Kangda International is a backbone enterprise in China's environmental protection industry and one of China's top 50 environmental enterprises. Kangda International is the most professional operation service provider, one of the first enterprises with the AAA credit rating in China's environmental protection industry, the vice chairman unit of the China Association of Environmental Protection Industry, and one of the leading companies in China's environmental protection and water service industries. The Company has always been committed to a century-old development plan with the vision of "leading the environmental protection industry and standing for a hundred years". Kangda International adheres to the four-in-one overall layout of "planning-investment-construction-operation", and continuously promotes the transformation from a traditional water treatment service provider to an urban environment comprehensive remediation service provider. Relying on rich development experience, first-class environmental protection technology, management system and management experience, we have provided strong support for environmental protection and sustainable development, achieved full coverage of the ecological chain of the environmental protection industry, and spared no efforts to fulfill corporate responsibility.

During the reporting period, the Company continued to focus on the work policy of "consolidating the foundation, increasing revenue and reducing expenditure", continuously optimized the flat management structure, and strictly controlled management and operating costs. In the future, we will continue to focus on the development of the main business of sewage treatment, further improve the quality of existing projects through upgrading and expansion, continue to optimize the management structure, follow policy trends, and seize market opportunities to explore and innovate. While seeking our own development, we will continue to promote the sustainable development of society, create higher value for shareholders, customers, and society, and contribute to the healthy development of society and business environment.



Kangda International corporate culture

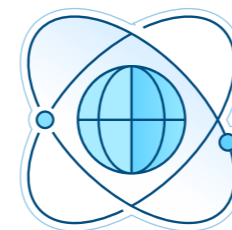

• Corporate policy

Following the rules, being self-disciplinary, fulfilling responsibility



• Corporate mission

Creating an environment of greener water, lush mountain and bluer sky



• Corporate vision

To lead the environmental protection industry and stand for a hundred years

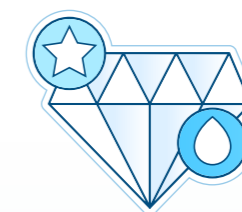

• Corporate core values

Integrity and responsibility, and giveback to society

Kangda International actively responds to the development policies in the environmental protection industry, and promotes the rapid development of the environmental protection industry by building an international environmental protection company with leading technology, sophisticated management, robust comprehensive service capabilities and strong brand influence. **During the reporting period, the Company won the 2020 China Top 50 Environmental Enterprises Award issued by the Environmental Chamber of Commerce of the All-China Federation of Industry and Commerce.**



1.2 Business Overview

Kangda International actively responds to the call for the reform of the ecological civilization system by promoting green development and deploying the strategy of building a beautiful China. While developing own business, we fulfill our environmental responsibilities as a corporate citizen. In 2020, we concentrated on urban water treatment as the main business while considering water environment comprehensive remediation and rural water treatment projects.

During the reporting period, the Company continued to penetrate the market focusing on environmental protection values. We had 112 projects nationwide that were distributed in 16 provinces and cities including Beijing, Tianjin, Liaoning, Jiangsu, Zhejiang, and Guangdong. Through a high-quality asset portfolio and a franchise-based business model, we maintained continuous operating cash flow, continued to create value for investors and society, and protected the interests of investors. As of the end of the reporting period, Kangda International recorded a revenue of RMB 3,332.4 million, an increase of approximately 18% over the same period last year.

Water Environment Comprehensive Remediation

Through the execution of the signed PPP and EPC contracts, the Company is engaged in water environment comprehensive remediation business, the scope of which includes comprehensive remediation and improvement of the river basin, treatment of black and odorous water body, construction of sponge city and so on. We are also committed to reducing risks by integrating resources to implement water environment comprehensive remediation projects under the EPC and operation and maintenance contracts. As of December 31, 2020, the Company had signed 2 PPP projects and 13 EPC projects, located in Henan, Jiangxi, Shandong and other provinces in Mainland China. The total revenue of these projects was RMB 311.7 million, an increase of 53% compared with the same period last year.

Rural Sewage Treatment

Rural water treatment includes the construction and operation of "beautiful villages", such as sewage treatment and sewage collection network to improve the rural living environment. As of 2020, Kangda International carried out three rural water treatment projects in Guangdong and Guizhou in mainland China. The Company generated incomes RMB 121.2 million with a year-on-year growth of 62%.

Urban Water Treatment

The Company's urban water business provides a number of service franchise arrangements based on contracts in such patterns as Build-Operate-Transfer (BOT), Transfer-Operate-Transfer (TOT), Public-Private Partnership (PPP), Build-Own-Operate (BOO), and Engineer-Procure-Construct (EPC) with operation and maintenance services covering the overall industrial chain of the urban water industry. Its scope includes the design, construction, upgrading and operation of sewage treatment plants, reclaimed water treatment plants, sludge treatment plants, and water supply plants, as well as the operation and maintenance of government-entrusted sewage treatment facilities.

As of December 31, 2020, Kangda International had established 112 projects related to franchised services, including 105 sewage treatment plants, 2 water supply plants, 3 sludge treatment plants and 2 water reclamation plants. The Company generated incomes of these projects of RMB 2,899.6 million, an increase of 14% compared with the data of the same period of last year. The details are shown in the figure as below:



In the future, we will continue to focus on the urban water treatment business, further expand the urban water treatment industry chain, and achieve the improvement of service quality and industry competitiveness.



1.3 Key Performance

Key statistics in 2020:



Operation

Revenue: RMB 3,332.4 million
an increase of about **18.4%** year-on-year

Gross profit: RMB 1,325.6 million
an increase of about **14%** year-on-year

Sales and distribution expenses: RMB 2.5 million
a decrease by about **49%** year-on-year

EBITDA: RMB 1,241.0 million
an increase of about **10.1%** year-on-year

Net profit: RMB 470.3 million
an increase of about **22.4%** year-on-year

Total assets: RMB 17,645.8 million
an increase of about **5.7%** year-on-year

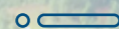

Society

Number of employees: 2,448, an increase of **5.8%** year-on-year
Total training hours for employees: 65,484
Average training hours for employees: 26.75

Obtained OHSAS 18001 Occupational Health and Safety Management System Certification

Carried out **more than 100** safety emergency drills
No employee deaths occurred due to work

A total of **22** intellectual property rights including patents and trademarks

Established cooperative relations with **216** suppliers
Equipment suppliers who passed **ISO 9001** quality management system certification and **ISO 14001** environmental management system certification accounted for **95%** and **76%** respectively



Environment

Obtained ISO 14001 environmental management system certification

Reduced water consumption intensity by **9%**
Reduced greenhouse gas emissions from direct energy by **5%**
Reduced intensity of sludge production by **13%**
Reduced total intensity of greenhouse gas emissions by **4%**



SUSTAINABILITY MANAGEMENT



2.1 Corporate Governance

Kangda International takes the sustainable development of the Company as its goal. Under the corporate vision of "leading the environmental protection industry and standing for a hundred years", we insist on creating a sound and complete corporate governance environment, establishing a corporate governance system with clearly defined powers and responsibilities, building an efficient and transparent governance structure, and continuously improving the risk identification, evaluation and decision-making mechanisms to fully protect the interests of the Company, customers, shareholders and other stakeholders.



Corporate governance

Kangda International strictly abides by relevant laws and regulations as well as rules and requirements of regulators in its places of operations. The Company conducts routine compliance inspection and complete compliance requirements as a response to internal and external environmental changes while encouraging all departments to review and update the internal management system regularly.



After years of growth, Kangda International has a complete corporate governance structure with the Board of Directors as the core. Our Board of Directors consists of 7 directors, including 4 executive directors (including one female member) and 3 independent non-executive directors. The Board of Directors makes decisions, manages and supervises the Company's production and operation. The Nomination Committee, Remuneration Committee and Audit Committee are set up under the Board of Directors, which are responsible for the overall governance, supervision and regular review of the Company to ensure that the Company's decision-making is rigorous and efficient. In addition, we are committed to establishing a Board of Directors with diversified members, and try our best to ensure the balance in the Board of Directors in terms of skills, experience and qualifications required for the Company's business, so as to enhance the effective operation of the board and maintain a high standard of corporate governance.



Kangda International attaches great importance to the management and control of various major risks, especially compliance risks. In order to better identify, evaluate, respond to, monitor and communicate various major risks, Kangda International revised and released the Risk Control Management System during the reporting period, and carried out a company-wide risk survey this year with a view to further improving its risk management policy and risk management system.

While strengthening governance, Kangda International regularly organizes training and learning to ensure the implementation of the risk control system and the development of risk control awareness and to improve risk prevention capabilities from the perspective of awareness. During the reporting period, various departments and branches of Kangda International launched relevant training and learning activities many times.

For details, please refer to the "Corporate Governance Report" of the 2020 Annual Report.



• Special training and learning scene on internal control and compliance management for related party transactions



2.2 ESG Management

Kangda International always attaches great importance to the concerns of all stakeholders, and constantly strengthens ESG management. Through close communication and interaction with stakeholders, we can better understand and respond to the concerns of stakeholders while constantly improving the Company's strategy.



Sustainable development concept

Since its establishment, Kangda International has satisfied stakeholders with our endless efforts in terms of objectives of social responsibility and wholeheartedly ensured their demands and rights.



"The highest good is like water, Water gives life to the ten thousand things and does not strive." Kangda International has always carried out its core business around "water" with the responsibility concept of "contributing to the world". We hope to be like a stream of water, surging and converging with all stakeholders to form a torrent of sustainable development. Not only can we flow endlessly, through mountains and into seas, but we can also nourish society, achieve mutual benefit and win-win cooperation with others, and create Kangda International's ultimate value for society as much as possible.

ESG governance structure

In order to better drive the implementation of the Company's ESG concept and strengthen the Company's sustainable development management, the Company has established a three-level governance structure composed of the Board of Directors, Working Committee and Working Group as the core. In addition, we appointed full-time employees to oversee ESG feedback and prepare ESG reports. Based on the ESG report, the company will continue to engage deeply the Board of Directors in the process of ESG risk assessment and management and upgrade the governance level of ESG in the future.





2.3 Materiality Analysis

Stakeholder communication

We communicate with stakeholders in various ways to understand their concerns, actively respond to issues with actions and timely review the effectiveness of such actions. During the reporting period, the issues of concern to different stakeholder groups and communication and response were as follows.

Stakeholders	Issues of concern	Communication and response
Shareholders/ investors	Business growth Policy implications Management structure adjustment Product and service quality Employee retention	General meeting / regular report / interim announcement Real-live roadshow and reverse roadshow Phone call and email correspondence
Governments and authorities	Policy implication Water eco-environmental protection Chemicals management Sludge treatment	Regular report / interim announcement Report and reception Correspondence Field research
Customers	Product and service quality Technology R & D and Application Supplier / contractor management Handling of customer complaints	Hotline Informative feedback Satisfaction survey
Employees	Occupational safety and health Employee retention Compensation and benefits Business growth	Safety training meeting Professional competence training Employee activities Daily communication, internal publicity and complaint feedback
Business partners (including suppliers and contractors)	Supplier / contractor management Business performance Policy implications Construction site management	Open bidding Annual assessment Field research Supplier meeting
Community	Philanthropy Community participation and development support Water eco-environmental protection Sludge treatment	Community events / announcements / press releases Visits and investigations Field research

Assessment of material Issues

On the basis of the assessment of material issues in the previous year, we adjusted some material issues in accordance with the Company's operating conditions, concerns of stakeholders, current development of the industry, and the situation of the Covid-19 epidemic. A total of 22 ESG issues were identified during the reporting period, of which 10 were of high importance, 8 were of medium importance, and 4 were of low importance. The key part of this report is composed of highly important issues, which will be disclosed in this report in detail.

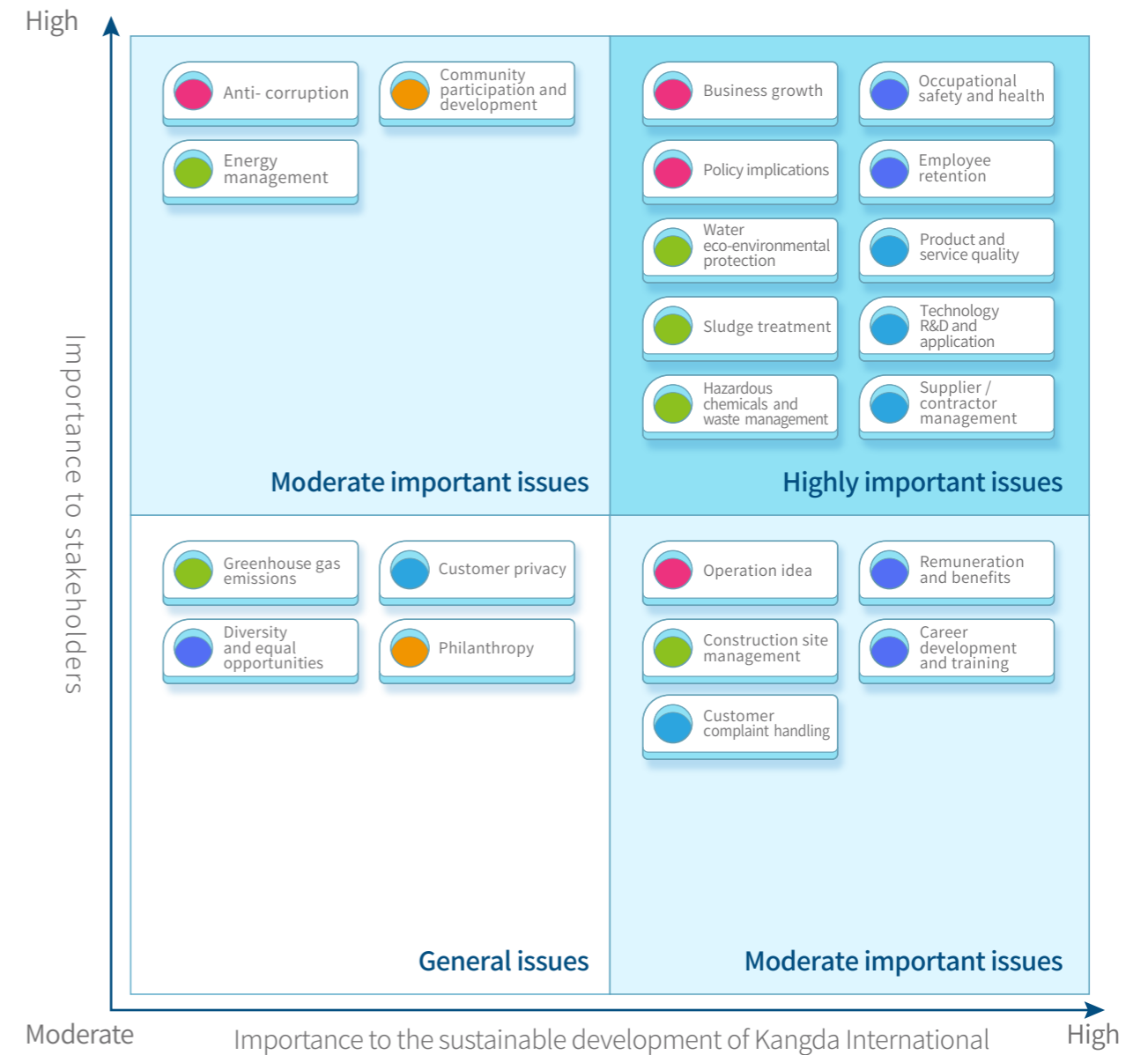

- Economics and governance issues
- Environment issues
- Labor issues
- Product and service issues
- Community issues

• Kangda International 2020 ESG Materiality Matrix



2.4 Operation with Integrity

Honesty, trustworthiness, and compliance management are the foundation for Kangda International to ensure healthy and long-term development. We strictly abide by laws and regulations such as the Anti-Unfair Competition Law of the People's Republic of China, the Anti-Money Laundering Law of the People's Republic of China, and the Interim Provisions on the Prohibition of Commercial Bribery, and have formulated the management system documents such as the Anti-fraud Management System of Kangda International, the Employee Reporting Policy, the Internal Audit Management System, and the Code of Business Conduct on Anti-fraud. During the reporting period, we formulated and issued the Code of Business Conduct on Anti-Corruption and Bribery to further improve the anti-corruption system with a view to effectively eliminating commercial bribery and other improper behaviors that violate business ethics. During the reporting period, we did not have any corruption lawsuits.

We encourage stakeholders such as employees, customers and suppliers to report any suspected violations of the Company's business code of conduct or any applicable laws or company policies. We strive to establish an efficient and transparent reporting mechanism, and the internal audit department is solely responsible for all reported information. In addition, we attach great importance to the privacy protection of whistleblowers to ensure that all whistleblowers will not be treated unfairly.



Hotline and email address for bribery or corruption reporting

Hotline	86-23-61687966
Email	neishenbu@kangdaep.com

We always regard the culture of integrity as an important part of the corporate culture. During the reporting period, the subsidiaries and branches of Kangda International organized several anti-corruption and integrity seminars to help employees establish honest and pragmatic values. In addition, we compiled two issues of an anti-fraud journal and published them through the OA (Office Automation) system to all employees for independent learning, so as to constantly internalize the culture of integrity into employees' conscious and self-reflective actions.



• Kangda International (Shangqiu) Water Co., Ltd. held a special meeting to study the "Anti-fraud Journal"



• Wenzhou Chuangyuan Water Co., Ltd. launched a meeting to study the anti-corruption system



SHARED DEVELOPMENT

Kangda International always implements the quality-first development strategy by continuously improving the quality management level of project construction and project operation and insisting on innovation and research and development to elevate product quality. At the same time, we actively carry out industry-university-research cooperation and work with all parties to promote industrial upgrading and progress and contribute more to the improvement of the water environment quality and the construction of ecological civilization.

Quality Upgrade
Innovation and R&D
Responsible Supply
Industry Contribution

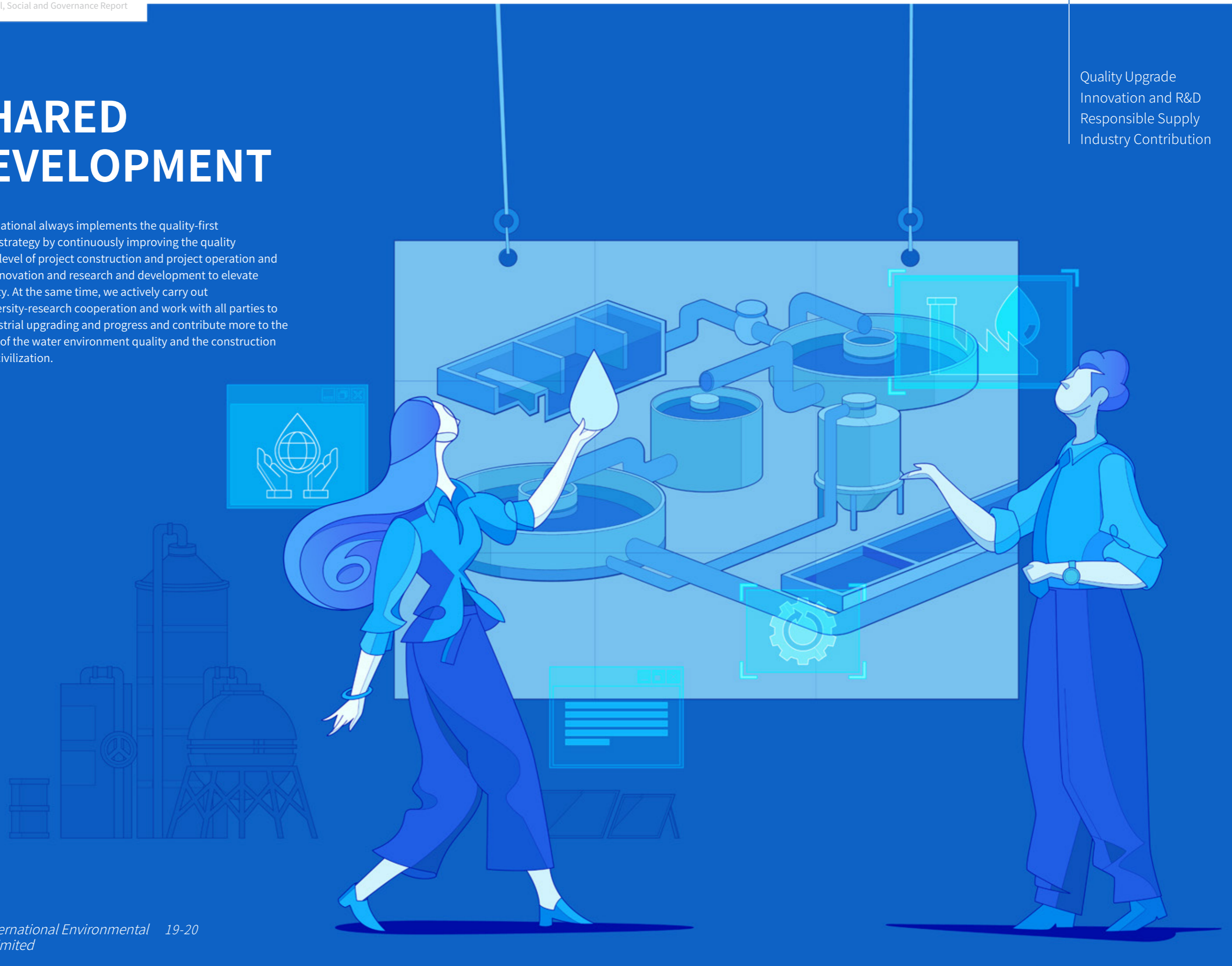

SHARED DEVELOPMENT

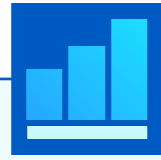

3.1 Quality Upgrade

Excellent product quality is the key to winning the trust of customers. Kangda International pays consistent attention to building a complete quality responsibility management system and continuously improving the quality of project construction and project operation in an effort to build the ecological civilization and realize the aspiration of lucid waters and green mountains.



Project construction

Kangda International strictly follows the national laws and regulations such as the Construction Law of The People's Republic of China, the Rules on the Construction Quality Management, the Compulsory Provisions of Engineering Construction Standards (Building Part) and maintains the unremitting pursuit of the quality of construction projects. In the process of design and presentation, we always pay attention to the acquisition of various qualification documents for project construction, and ensure that the qualification documents such as "Construction Project Planning Permit", "Construction Land Planning Permit", and "Construction Project Construction Permit" have been obtained before construction. In the construction stage, we constantly improve the project quality management framework as it adopted the project quality manager accountability system and the lifelong accountability system. As the primary responsible person for quality assurance, the project manager dynamically grasps the quality of the project under his jurisdiction, and continuously regulates and improves the project quality management through regular supervision meetings and daily morning meetings. Project acceptance is an important part of ensuring the quality of the project. We strictly implement the "three inspections" acceptance procedures, pay attention to standardizing data sorting and filing, and continuously facilitate the overall virtuous circle of project construction.



Project operation

For project operation, following the requirements of Law of the People's Republic of China on Product Quality, the Law of the People's Republic of China on the Prevention and Control of Water Pollution and other laws and regulations, Kangda International has developed Internal management system and requirements such as the Technical Specification for Operation, Maintenance and Safety of Urban Sewage Treatment Plants, the Operation Instruction for Equipment in Urban Sewage Treatment Plant, the Operation Instruction for Process in Urban Sewage Treatment Plant, so as to ensure that the effluent quality of sewage treatment plants are up to the standards of GB 18918-2002 Discharge Standard of Pollutants for Municipal Wastewater Treatment Plant.

• Operation quality management

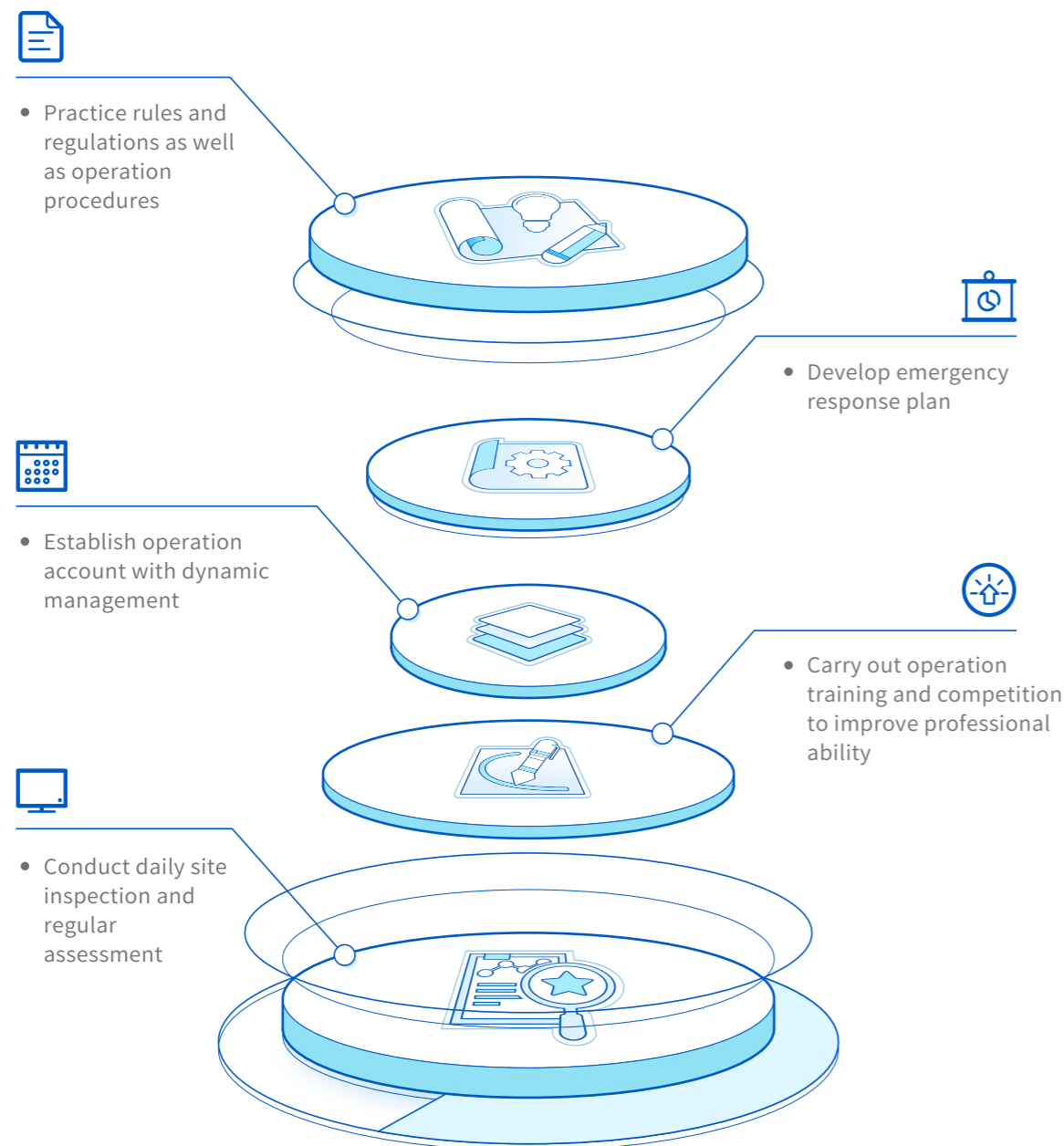

In addition, in order to continuously improve the effectiveness of water quality monitoring, we have established a water quality working mechanism of laboratory and online instrument monitoring, and continuously improve water quality early warning monitoring and emergency response capabilities through joint collaboration, thereby protecting production and operation.



Water quality laboratory monitoring

By strengthening the monitoring of the quality of incoming and outgoing water and the quality of raw material processing chemicals, we feed the data back to the operation scheduler as soon as possible to provide accurate data reference for production scheduling.



Online instrument monitoring

We set up online instrument administrators responsible for maintaining important instrument, providing reference for process operation, supervising the operation and maintenance work of third-party units, and ensuring that the factory accurately uploads online data to the environmental protection platform and be fed back with the water output data in real time.

Fighting the epidemic by sticking to the last line of defense in sewage treatment

Kangda International's Jiaozuo No.1, No.2 and Wanfang Industrial Cluster sewage treatment plants are responsible for the collection and treatment of all sewage in the main urban area of Jiaozuo City. They are an important barrier for the prevention and control of water pollution in Jiaozuo City. During the epidemic, the Company's three sewage treatment plants maintained stable operation.



After the outbreak of the Covid-19 epidemic, the Company strengthened organization and leadership to establish an epidemic prevention and control mechanism; increased publicity and investigation efforts to ensure that the epidemic prevention materials were in place; strengthened personnel management and improved emergency prevention and control capabilities; implemented the daily epidemic report system and ensured smooth information communication to comprehensively and solidly prevent and control the epidemic. With rapid actions, careful deployment, strong guarantees, and strict implementation, the Company was united to increase process inspections, rationally adjust processes, increase monitoring frequency, ensure the stable operation of sewage treatment equipment and facilities and the compliant discharge of effluent water, and double down on strengthening effluent and sludge disinfection. By sticking to the last line of defense in sewage treatment in the city and making every effort to fight the epidemic, we protected the health and safety of citizens, fulfilled the mission and responsibilities of environmental protection enterprises, and interpreted the noble professional ethics and life values of Kangda International with practical actions.



3.2 Innovation and R&D

Strong innovation and technology R&D capabilities have always been one of the core competitiveness of Kangda International for sustainable development. We continuously explore cutting-edge technologies in the industry, strengthen the integration and layout of technologies and processes, give full play to the leadership of the enterprise in innovation, and help improve the technology development in the industry.



Promoting the application of new technologies

We always insist on innovation-driven development, continuously increase innovation, research and development and the application of new technologies, and promote the upgrading and development of the enterprise. During the reporting period, the sewage treatment plants built and operated by the Company actively explored and applied a series of new technologies to provide guarantees for improving operational efficiency and environmental protection.



Innovative AAO+A/O process

On the basis of the original AAO (Anaerobic Anoxic Oxic) + A/O (Anoxic/Oxic) biochemical treatment process, a flow thruster was installed at the terminal of the first O tank (oxic tank) to control the dissolved oxygen at this place, maximize the anoxic operation effect of the two anoxic tanks, and make the maximum use of the carbon source for nitrogen removal, thereby reducing operating costs.

Advantages: Compared with before the improvement, the current AAO+AO biochemical treatment process has realized precise dosing of carbon source, reduced the dosing amount of carbon source, improved the treatment efficiency of the biological tank, and reduced the operating cost.

Application: This innovative process was adopted in the renovation plan of Weifang Yuhe Sewage Treatment Plant in 2020.



Improved high pressure filter press

With the addition of a small amount of commonly used dewatering agents, the high-hydraulic-pressure mechanical filter press can reduce the moisture content of the sludge from 80-85% to 40-50% according to the requirements for subsequent sludge disposal process.

Advantages: Compared with the original belt filter press, the high-pressure filter press can greatly reduce the moisture content of the sludge. The sludge after deep dewatering and heavy metal removals has a higher calorific value, which saves the secondary processing costs for subsequent processes such as incineration, carbonization, and brick making.

Application: It was put into operation at the end of 2020 and is currently in the stage of operation and debugging.



Liftable aeration system

Various aerators fixedly installed at the bottom of the original tank can be directly transformed into liftable tube-type microporous aerators under the condition that the original air inlet pipe remains unchanged.

Advantages: relatively simple and quick installation, convenient maintenance, able to improve aeration efficiency and sewage treatment capacity. No air purification is required, and it is more convenient to control the operation process.

Application: In 2020, the liftable aeration system was adopted in Yucheng, Shanxian, and Puyang, and existing aeration systems were replaced or repaired under the condition of normal production.

In addition, under the development background of improving quality and efficiency, we pay consistent attention to market opportunities and the status quo of industry technology development, continuously explore the chemical delivery practice in the operation link, and strive to improve the comprehensive competitiveness in terms of material delivery solutions.

• Selection of high-efficiency sludge dewatering agents

During the reporting period, through on-board tests we converted the currently used sludge dewatering agents (quick lime, iron salt) into high-efficiency sludge dewatering agents to reduce the amount of agents used in the sludge dewatering section. Under the condition that the moisture content of the sludge effluent is basically unchanged, the additional dosage of agents is reduced, suggesting high economic feasibility.



• Sludge produced with original agents

• Sludge produced with current agents

• Hydrolysis tank improvement

During the reporting period, Shandong Weifang Yuhe Plant, Shandong Gaomi No. 2 and No. 3 plants were upgraded, in which the original hydrolysis and acidification tanks were converted into anoxic tanks. By reducing the carbon source consumption of the front-end pretreatment and increasing the residence time of the biochemical section, this project improved the utilization efficiency of carbon sources in sewage, thereby achieving the purpose of reducing the amount of carbon sources added. After the transformation of the hydrolysis tank, under the condition that the effluent reaches the standard, the original dosing of a small amount of carbon source has been changed to the current non-dosing of carbon source.



• Hydrolysis tank reconstruction scene

Industry-university-research cooperation

Kangda International actively builds close cooperative relations with governments, enterprises, universities and scientific research institutions. While focusing on the update and iteration of existing technologies, we constantly research and develop new technologies and new processes, and work hand in hand with more partners to build a collaborative and healthy industrial ecology.

Establishment of Tsinghua - Kangda Research Institute of Environmental Nano-Engineering & Technology

During the reporting period, we teamed up with the Shenzhen Graduate School of Tsinghua University to establish the Research Institute of Environmental Nano-Engineering & Technology. We will invest a total of RMB 50 million in the next 5 years to support the research institute to establish a technology research and development platform, cultivate high-level R&D talents and continuously research and develop serialized technologies and equipment. This cooperation will significantly promote the innovation of our technological model and industrial chain format, and continuously enhance our core competitiveness in the water service sector.

Intellectual property protection

In the process of continuous technological innovation and change, Kangda International has always attached importance to and strengthened the protection of intellectual property rights. We strictly abide by the Patent Law of the People's Republic of China, the Trademark Law of the people's Republic of China, the Law of the People's Republic of China Against Unfair Competition and other laws and regulations. We pay attention to unifying and standardize the management of all aspects including the collection, generation, review and release of intellectual property-related information, actively cultivate intellectual property innovation culture, improve employees' respect for intellectual property rights, and consistently encourage innovation. As of December 31, 2020, we had a total of 22 intellectual property rights including patents and trademarks.



3.3 Responsible Supply

Kangda International actively implements responsible supply and constantly improves its supplier management system. We have formulated the Supplier Management System and the Contractor Management System, concerning product quality in the supply chain, system construction, integrity and anti-corruption, and actively integrate the concept of sustainable development into supplier management, so as to comprehensively promote win-win cooperation in the industry chain.

Our suppliers mainly include equipment suppliers and engineering contractors during project construction, as well as chemicals suppliers during project operation. For suppliers in each link, we continuously improve the supplier management system, reduce supply chain risks in terms of supplier access, review, and exit, and ensure the stability of production and operation.

• Kangda International Supplier Management Measures

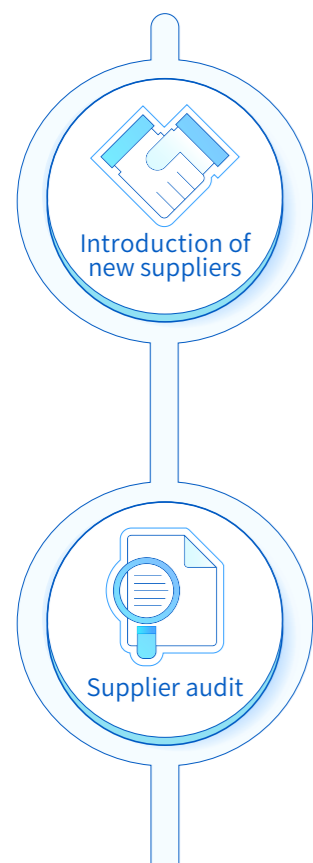

Equipment suppliers and engineering contractors

Introduction methods: information-based search, recommendation from location where project operates, door-to-door visit

Evaluation items: focus on compliance, product and service quality, safe production and environmental management ability

Audit frequency: annually / irregular reviews during construction

Audit process: conduct sampling inspection on the factory, business locations and project cases on a regular basis every year. Pay attention to the timeliness of supply, project progress, business effectiveness, professionalism, supply quality and after-sales service during the project construction

Audit and evaluation: potential suppliers, qualified suppliers, unqualified suppliers, strategic suppliers, blacklisted suppliers

Chemicals providers

Introduction methods: centralized procurement by province every year. Generally, over three suppliers are selected for the same type of chemicals to ensure stable supply

Evaluation items: focus on the supply price, delivery period, product quality and after-sales service

Audit frequency: annual supplier review

Audit process: For quantitatively advantage of chemicals supply, control the quality and price of supplied products and ensure the stability of supply. Established a cross-department joint chemicals procurement team and database of chemicals suppliers during the report period

Audit evaluation: excellent suppliers, good suppliers and qualified suppliers

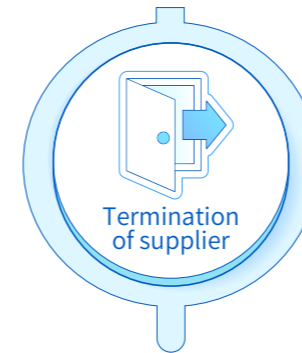

Service List the suppliers/contractors with mistakes or reviewed as unqualified on the unqualified supplier/contractor database and blacklist them in case of serious mistakes

In the subsequent centralized procurement, fully consider the recorded mistakes of suppliers; terminate or reduce the procurement as appropriate

We have worked to establish a comprehensive supply chain system with an open mind. As of December 31, 2020, we had established cooperative relationships with 216 suppliers, including 125 equipment suppliers, 52 engineering contractors, and 39 chemicals suppliers.

• Equipment suppliers during project construction

Distribution of equipment suppliers during project construction

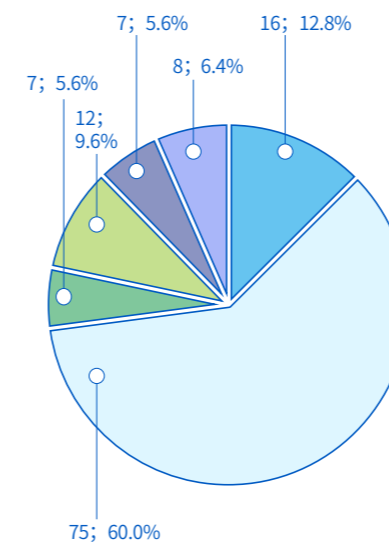

North China East China
South China Central China
South-West China Other regions

• Engineering suppliers during project construction

Distribution of engineering contractors during project construction

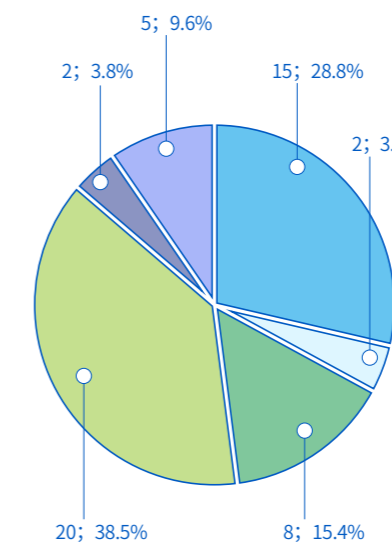

North China East China
South China Central China
South-West China Other regions

• Chemicals suppliers during project operation

Distribution of equipment suppliers during project construction

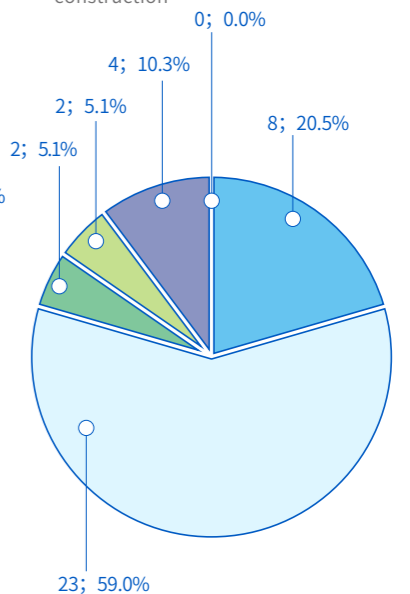

North China East China
South China Central China
South-West China Other regions

• Proportion of certified distribution of equipment suppliers during project equipment

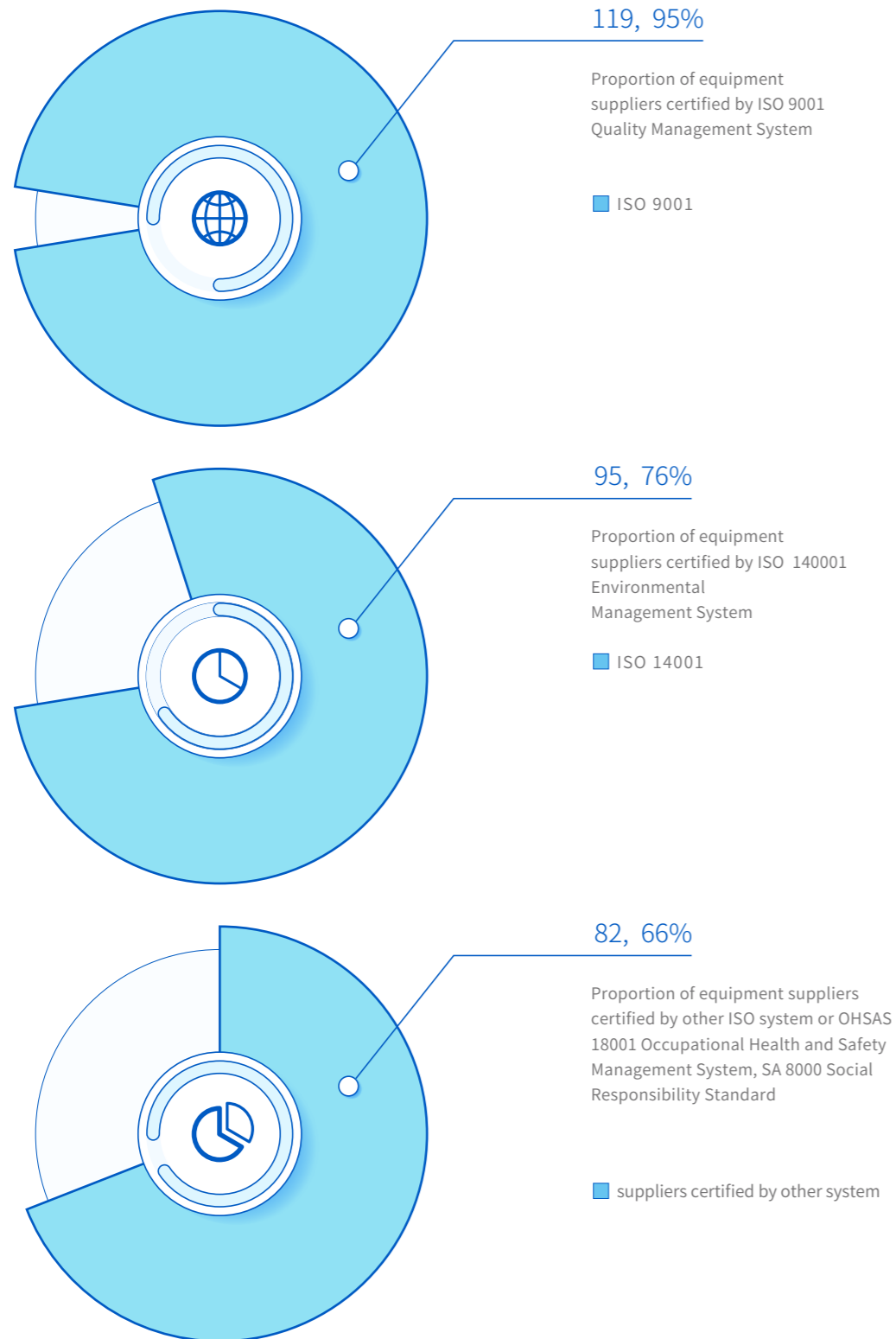

During the reporting period, we strengthened the unified procurement of chemicals, and achieved good results in ensuring the quality of chemicals, stabilizing procurement prices, and coordinating procurement and supply.

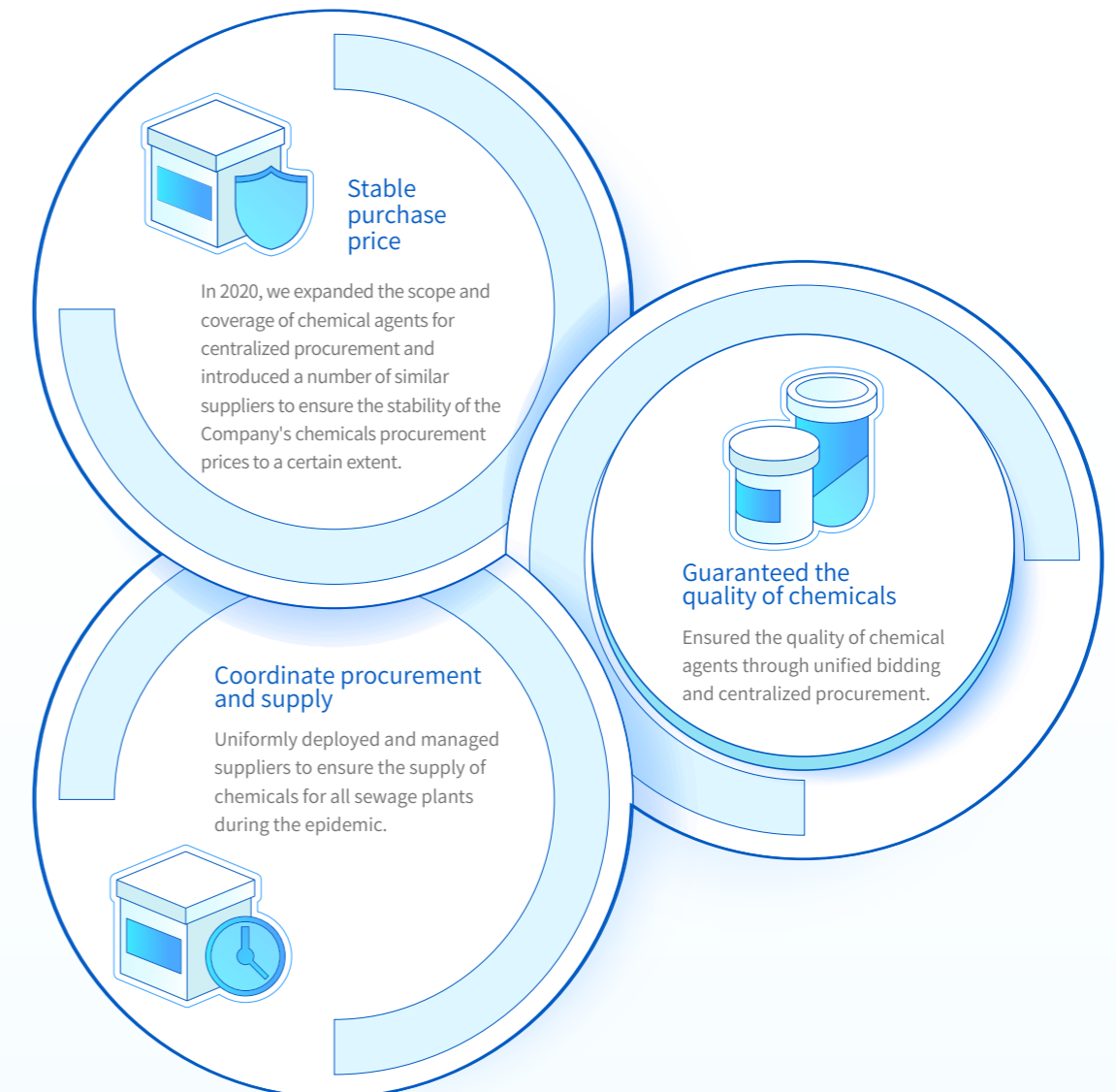

Kangda International has always maintained an open and transparent communication mechanism with suppliers. During the reporting period, we carried out multiple site inspections and communication activities with suppliers to continuously create a mutually beneficial and win-win cooperation ecosystem.



• On-site supplier inspection



3.4 Industry Contribution

Kangda International always believes that the development of the sewage treatment industry requires the cooperation with the government, enterprises and professional institutions. We actively carry out in-depth cooperation with all parties in technology research and development, standard formulation, process optimization, etc., and participate in industry conferences and exchange activities to share innovation and R&D results and advanced management experience, thereby continuously promoting the green and healthy development of the industry.



Participating in the formulation of the Technical Regulations for Magnetic Media Coagulation and Sedimentation for Sewage treatment

During the reporting period, the "Technical Regulations for Magnetic Media Coagulation and Sedimentation for Sewage Treatment" of the China Association for Engineering Construction Standardization of which we participated in the formulation was successfully implemented. The Regulations explain mainly the system configuration, process design, testing and control design, installation, commissioning and acceptance, operation and maintenance, and so on, coupled with magnetic medium coagulation sedimentation system process control charts and main equipment selection tables, with a view to continuously promoting the development of the technology of magnetic medium coagulation and sedimentation for sewage treatment.

Participating in the 2020 Drainage Conference

During the reporting period, we participated in the 2020 Drainage Conference hosted by the "Water Supply and Drainage" magazine. This conference set up the two sub-forums of "China Urban Sewage Treatment System Quality and Efficiency and Smart Drainage Forum" and "China Urban Municipal Sludge Treatment and Disposal Technology Forum", covering topics such as sewage treatment plant quality improvement, energy saving and consumption reduction, pipeline network renovation for connection errors, pipeline network renewal, damage repair, and safe treatment and disposal of sludge. Through this conference, Kangda International conducted extensive communication and exchanges with water supply and drainage operation management and design enterprises, university research institutes, equipment system suppliers, etc. from all over the country, and learned advanced technology and excellent experience in the industry, which provided reference for Kangda International in energy saving and consumption reduction, revenue increase and expenditure reduction, and other aspects.

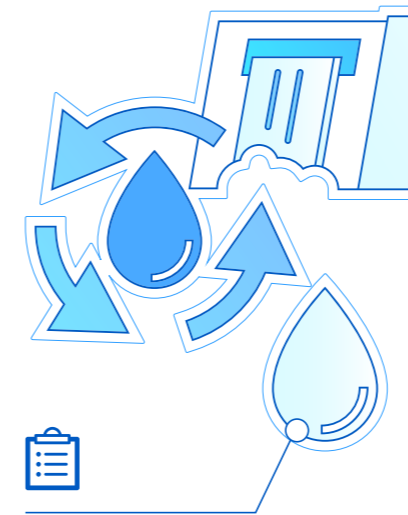

- Water environment governance
- Water resource utilization
- Water ecological protection

Kangda International closely follows the policies and guidelines of water environment governance, water resources utilization, and water ecological protection promulgated by the national and local governments, and continuously improves the modernization level of environmental and ecological governance capabilities. During the reporting period, we received on-site inspections, supervision and guidance, and visits and investigations from various provincial, municipal, district governments and relevant ecological environment regulators. We took advantage of the on-site exchanges to share the role and value of Kangda International in maintaining the sustainable development of the environmental industry as a backbone force in China's environmental industry.



• The Department of Housing and Urban-Rural Development of Henan Province and the Urban Sewage Treatment Plant of Henan Province visited Zhengzhou Xinzhongzhou Water Co., Ltd. for supervision and inspection



• Leaders of Shandong Dong'e County Government visited Kangda International for guidance

TALENT DEVELOPMENT

Kangda International is committed to building a fair and just employment environment as well as a safe and healthy workplace for employees. In order to achieve mutual benefit and win-win situation between the Company and employees, we fully respect and protect each employee's rights and attach great importance to employee's growth, career development and welfare.

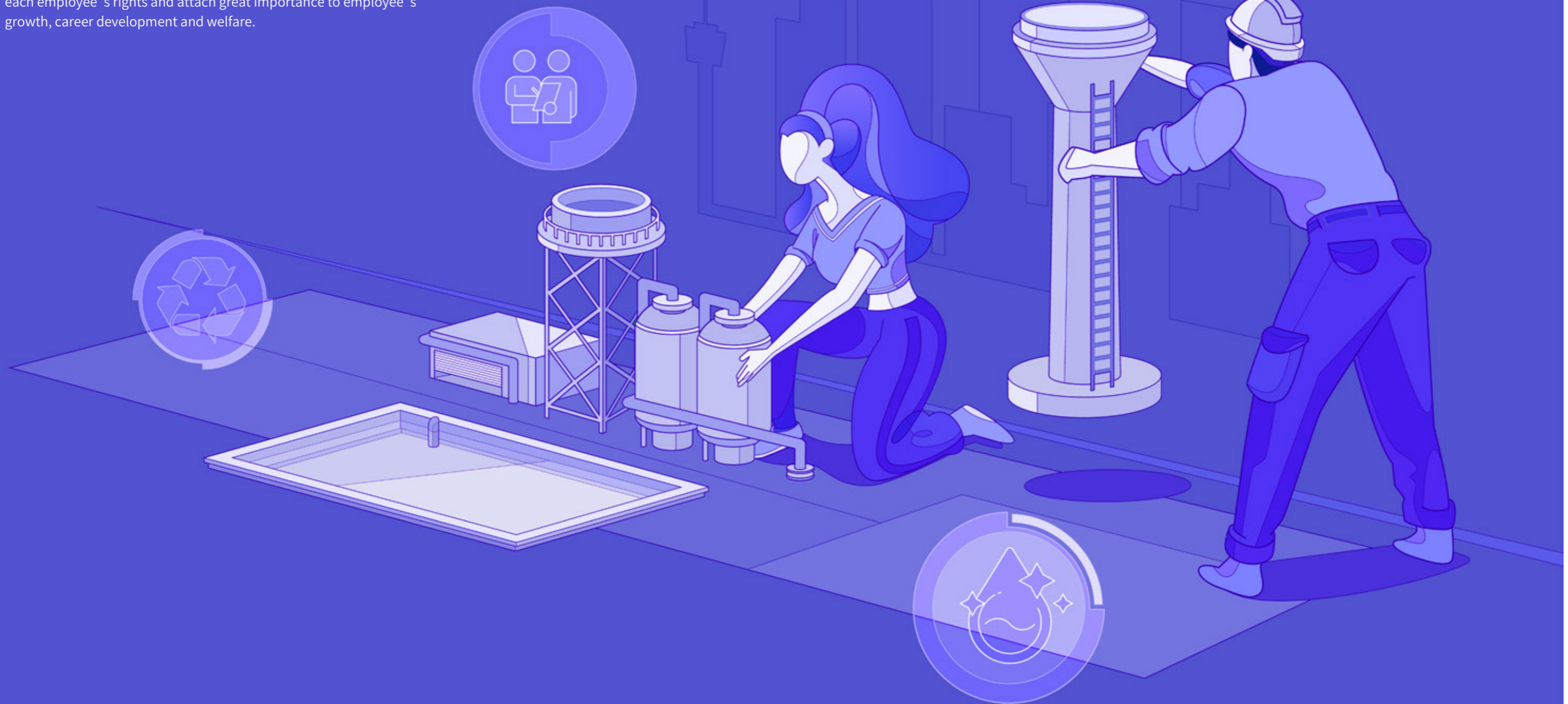

TALENT DEVELOPMENT

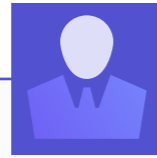

4.1 Employee Employment

Kangda International has always implemented the "value creator-oriented" concept, and is committed to building a healthy, harmonious and equal employee employment system that meets the needs of the Company's sustainable development. Kangda International insists on legal compliance. On the basis of strict compliance with the Labor Law of the People's Republic of China and other laws and regulations, combined with our characteristics and advantages, we have refined or formulated internal recruitment and employment management systems such as the Staffing Management System, Recruitment Management System, and Employee File Management Measures. In the recruitment process, we adhere to the principle of open plans, open positions, fair process, fair evaluation, and equal employment to recruit talents that promote the sustainable development of the Company.

During the reporting period, we had a total of 2,448 employees, an increase of 5.8% over the previous year.

• Number of employees by gender

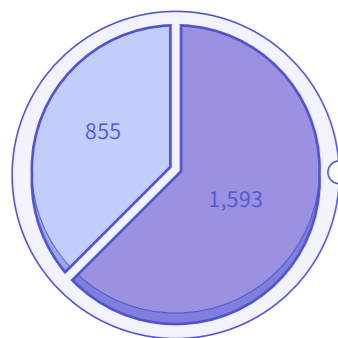

• Number of employees by age

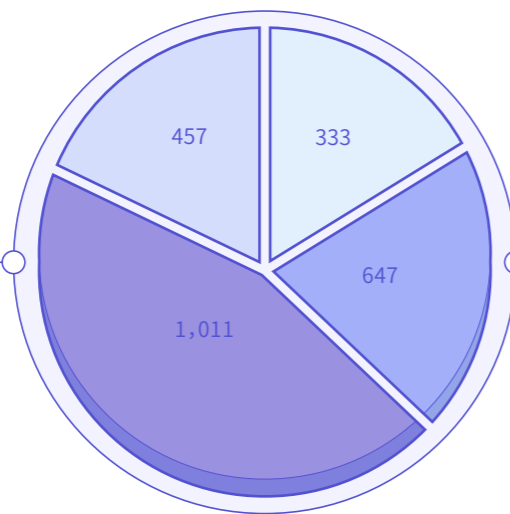

• Number of employees by level

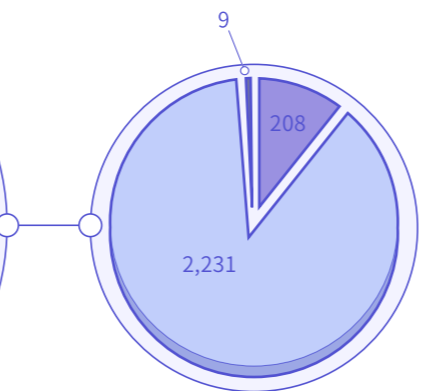

- Male
- Female
- Equal to and above 50
- 40-49
- 30-39
- Equal to and under 29
- Senior management
- Middle management
- General employee

Kangda International responded to the challenge of the epidemic with a positive attitude. We enhanced employees' sense of belonging and identity through measures such as improving the employee welfare system, retaining outstanding employees, and providing work and life assistance to employees in difficulties, so as to achieve talent retention. During the reporting period, the total turnover rate of Kangda International's employees was 4.68%, as shown in the figure below:

• Turnover rate by Gender

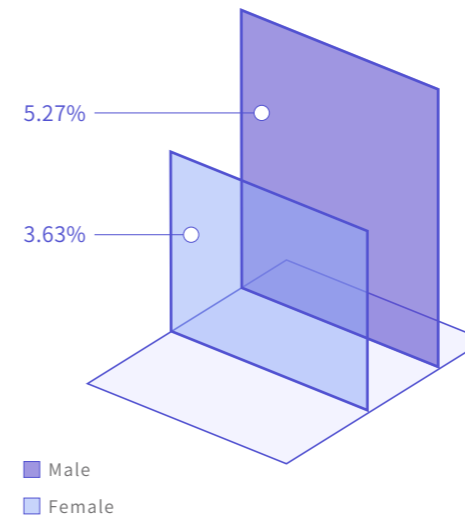

• Turnover rate by Age

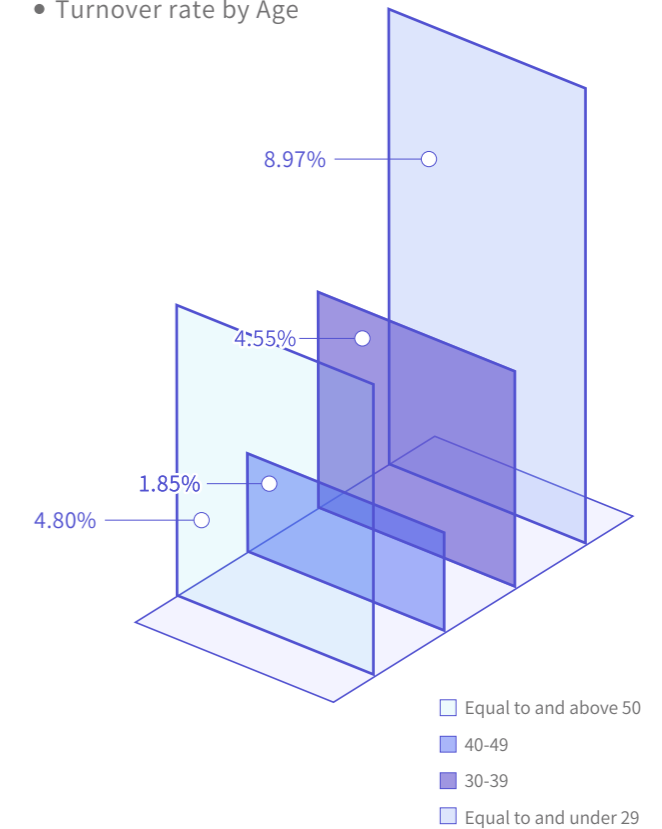

Kangda International simultaneously updated the Salary Management System (Revised) and Attendance Management System (Revised), and formulated a competitive salary standard in the industry and a reasonable salary incentive mechanism, so as to protect the rights and interests of employees, fully mobilize the enthusiasm and centripetal force of employees, and realize the common development of employees and the Company in a harmonious working atmosphere.

Respect for diversity

Kangda International resolutely resists discrimination on gender, ethnicity, religious beliefs, social status, etc., prohibits the employment of child labor and forced labor, insists on equality for all, and strives to create a working environment of mutual respect, inclusiveness, and mutual assistance, enhance the happiness and satisfaction of employees and promote the diversified development of employees. During the reporting period, the Company did not engage in any illegal employment of child labor or forced labor.

Kangda International has established an internal audit department to strictly abide by the Code of Business Conduct, the Law of the People's Republic of China on the Protection of Minors, Provisions on Prohibition of Child Labor and other laws and regulations, continuously improve the standardization of the approval process, and strive to control employment violations and personnel discrimination from the source. We encourage employees to report violations, and on the basis of protecting the informant's information, we will respond quickly and resolutely eliminate all violations.



4.2 Talent Development

Kangda International regards talents as the core of corporate development. By improving the employee training system, optimizing the employee development system, and enriching the professional knowledge and job skills of employees, we allow every employee to get opportunities for learning and progress, fair development, and just promotion.



Operation Management Training for Deputy General Managers

In order to strengthen the construction and operation management of environmental protection engineering projects, strengthen the exchange of experience and work contacts between the Company and the project department, consolidate the professional ethics of cadres at all levels, improve work quality and efficiency, and improve management skills, we convened a "Work Conference on Training for Deputy General Managers of Operating Companies". During the meeting, many responsible persons summarized and shared the work experience with Safety Production and Emergency Response and From Cultural Recognition to Management Improvement, which effectively improved the management's work skills and strengthened the Company's upstream forces.



Talent strategy

Based on the characteristics of internal structure, Kangda International has formulated the Training Management System (Revised), encouraging all departments to make full use of internal and external trainers to organize various training projects according to their work needs. Training courses include compulsory courses, elective courses and special courses, covering a diversified training system composed of vocational skills training, leadership training, management communication training, etc., with the aim to improve the overall quality and ability of employees in all aspects. We also encourage the use of exams to stimulate learning and the application of the knowledge learnt to ensure the effectiveness and professionalism of the training implementation. In 2020, we carried out a number of training activities such as related-party transaction training, Kangda International's work conferences on construction management and operation, and production safety training, all of which achieved good results.

Kangda International also places emphasis on talent protection, provides promotion channels and opportunities for employees at all levels, and strives to create opportunities for employees, thereby helping employees realize their self-worth and share development results with the Company. Regarding performance appraisal, Kangda International has formulated and issued the Performance Assessment Management Measures for Member Enterprises (Revised), which clarifies the appraisal indicators and links them with remuneration and incentives to create an overall working atmosphere of open, fair and healthy competition.

During the reporting period, Kangda International trained a total of 12,650 person-times, with total training time of 37,502 hours, an average of 17 hours per person.

• Employee training hours by gender (hours per employee)

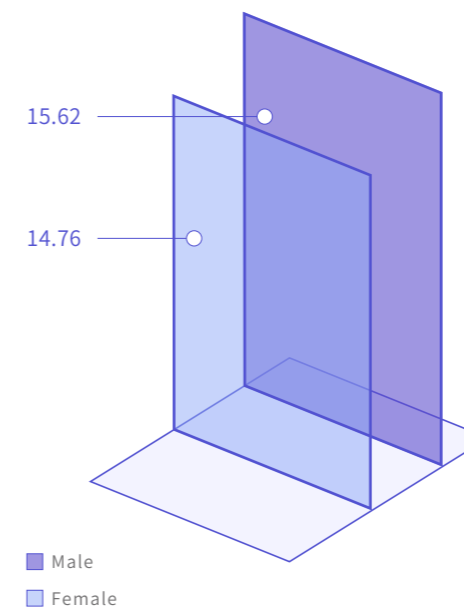

• Employee training hours by level (hours per employee)

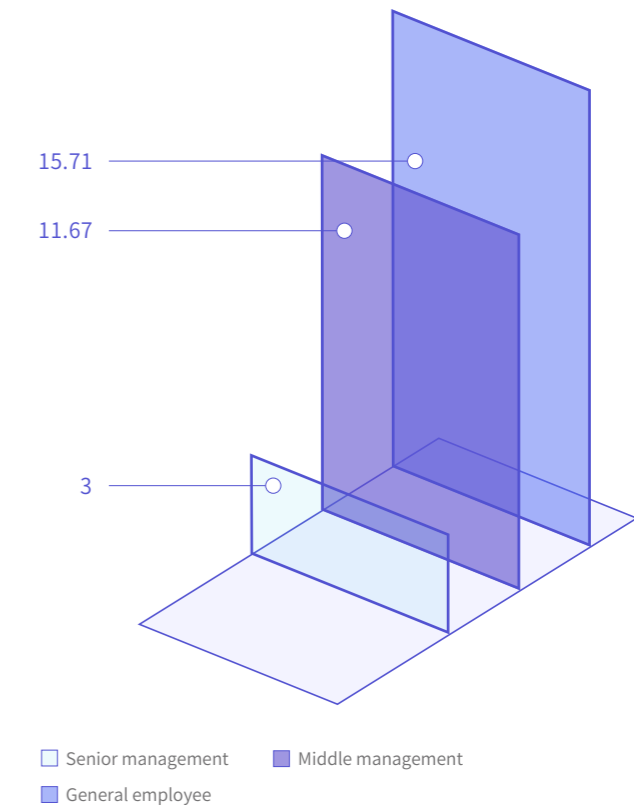

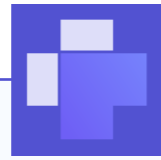

4.3 Health and Safety

It is the responsibility of an enterprise to protect the health and safety of employees. Kangda International attaches great importance to the safety work implementation, and is committed to providing a healthy, safe and comfortable working environment for all employees.



Safe production

Kangda International firmly believes that safety outweighs everything else. We strictly follow the Labor Law of the People's Republic of China, the Work Safety Law of the People's Republic of China, the Law of the People's Republic of China on the Prevention and Control of Occupational Diseases and other applicable laws. We have formulated the Management Methods of Chongqing Kangda International for Construction Projects (Trial), the Standard Collective Manual for Safe and Civilized Construction at Construction Site, the Chongqing Kangda International Comprehensive Emergency Rescue Plan for Production Safety Accidents and other regulatory documents. By carrying out the system, we continue to implement the safety management.

We have formed routine management of safety, implementing the requirements of the safety production system throughout the entire process of project operation and construction. In terms of construction, we establish annual safety management goals, requiring each management level to sign a M.B.O agreement and implement the requirements in the letter level by level to ensure that the management of safety production is "comprehensive and thorough". In addition, in order to reduce potential safety hazards, we require project safety engineers to conduct regular safety inspections on projects under construction and notify us in writing of safety hazards discovered during the inspections, for which a rectification deadline is set to reduce potential safety hazards and improve safety assurance.

Chemicals management

Kangda International constantly strengthens the safety management of chemicals. During the reporting period, we formulated the Chemicals Safety Management Regulations and refined the chemicals storage and management requirements in inventory management. Hazardous chemicals should be marked with emergency prompts for operation, as well as usage and first aid information. The work area and the chemical storage area should be cleaned in time. Operators are required to wear personal protective equipment when performing chemical operations, and it is strictly forbidden to bring fireworks into the chemical area. In addition, we carried out a number of training activities to organize various operating companies to learn and implement the use, storage, and emergency response of chemical agents.

Safety training

In order to enhance the safety awareness of all employees, we vigorously carry out safety training, and through the "Safety Production Month" and other theme activities, we help employees increase their safety knowledge, clarify safety production responsibility goals, routinize daily management work, and standardize on-site disposal, in order to create a good safe production environment and ensure the safety of employees' lives and property.



Daily safety training

- Adhere to the morning meeting system, implement daily work priorities and make safety disclosures
- Safety training for the Group's internal engineers
- Participate in safety training organized by external organizations or regulatory agencies such as the Emergency Management Agency



Safe Production Month

- Around the theme of Safety Production Month - "eliminating hidden dangers of accidents and strengthening lines of defense for safety", various operating projects carried out safety publicity and education activities in various forms to popularize safety production laws and regulations and safety production knowledge



Construction safety education

- All projects implement strict three-level safety education, and only those who pass the assessment can start to work
- On-site safety education before class

Emergency management

In order to prevent problems before they happen and improve the emergency response capabilities of all employees, Kangda International has established a safety emergency system. We have established a safety emergency response team, prepared Emergency Drill Management System, Emergency Response System, Emergency Plan for Leakage of Toxic and Hazardous Chemicals and other system documents, and formulated emergency response plans and other measures based on the graded response standards to fully guarantee smooth safe production.

We formulate an annual emergency drill education and training plan based on the emergency response plan, organize employees to conduct emergency rescue plan drills, and carry out emergency drills such as operations in confined space, fire, electric shock, flood prevention, heatstroke, and abnormal water quality for the Company's weak links in safety production. Through drills, we improve the scientificity, practicability and operability of the emergency plan, effectively enhance the safety awareness of the employees, improve their self-rescue and mutual rescue capabilities, and improve the Company's emergency response capabilities.

Kangda International issues to operating companies' production safety notifications and early warning of natural disasters such as typhoons and rainfall from time to time. During the reporting period, each operating company carried out more than 100 safety emergency drills, covering various aspects such as fire prevention, waterlogging prevention, operations in confined space, epidemic emergency response and manual first aid, which greatly improved the emergency knowledge and handling capabilities of the Company's personnel from various positions.



• Emergency drills

Occupational health and safety

In order to ensure the health and safety of employees, Kangda International strictly implements the requirements related to occupational health and occupational diseases. We comply with the Labor Law of the People's Republic of China, the Law of the People's Republic of China on the Prevention and Control of Occupational Diseases, the Regulation on Work-Related Injury Insurance and other applicable laws and regulations and actively carry out the work of labor hygiene and occupational disease prevention and control. We have passed the OHSAS 18001 Occupational Health and Safety Management System certification. During the reporting period, we further revised the Occupational Health and Safety Management System based on the actual situation of the Company in order to continuously improve the occupational health management system and enhance employee on-job safety.

In addition, we regularly carry out safety risk identification and formulate relevant control measures to reduce employees' occupational health risks. The Environmental List of Dangerous Equipment and Facilities, List of Posts Involved in Dangerous Operations, List of Hazard Identification and Assessment, Summary of Major Hazards, and Description of Major Hazard Control Measures are formulated during the construction of the project to clarify occupational health and hazardous operation risks and improve employees' awareness of prevention. We also provide employees with occupational health checkups on a regular basis to protect their health.

Good personal hygiene habits and healthy immunoprotection will reduce the risk of occupational disease infections. We encourage employees to develop correct hygiene habits in their daily work, and have formulated relevant requirements and response measures for the hazards of microorganisms, chemical substances, poisonous and harmful gases and electrical accidents.

• Our work-related injuries during the reporting period are as follows:

Indicator	2020
Number of work-related injuries(person)★	2
Hours of work-related injuries (hours)	444
Number of work-related fatalities (person)	0
Number of traffic accidents of employees on the way to company	1

Epidemic prevention and control

In 2020, facing the Covid-19 outbreak, the Company actively responded to the government's call and fully cooperated with the epidemic prevention work to protect the health of employees. During the difficult period of the epidemic, we were an important line of defense for epidemic prevention and control. While safeguarding the safety and health of employees, we maintained the "water health check". Subsidiary companies established epidemic prevention and control teams and prepared epidemic prevention and control work plans. While protecting employees' safety, we stuck to the front line. In the early stage of the epidemic, we arranged for some employees to work from home and implemented the shift working system for other employees. After the resumption of work and production, in accordance with the government requirements of orderly resumption of work, we took measures such as daily disinfection, body temperature detection, provision of masks, "bring your own tableware", and meals at one-meter intervals to smoothly ensure production and operation and the health of employees during the epidemic. During the reporting period, we had no cases of employees contracting Covid-19.

★ This is a traffic accident on the way to and from work. We have declared work-related injuries for our employees and dealt with them in a timely manner. At the same time, we have strengthened safety education to enhance their awareness of traffic safety and work safety.

Equal emphasis on "anti-epidemic and production"

The general manager of the Jiaozuo Company took the lead in the front line of epidemic prevention and control. He personally formulated epidemic prevention work plans, observed every effluent indicator, strengthened the dosing and disinfection of effluent water, propagated epidemic prevention knowledge to every employee on the job, and inspected whether the disinfection work was proper at every place and whether each worker wore a mask correctly. Thanks to his efforts, the factories of Jiaozuo Company responded to the epidemic quickly with careful deployment, strong guarantees, and effective implementation. During the entire period of the epidemic, the effluents met the standard, and the local government departments spoke highly of it.



In addition, we carried out epidemic prevention knowledge publicity and implementation for each project company, and required each project company to strictly manage personnel and do a good job in epidemic prevention and control.



• Epidemic prevention and control measures at the project site



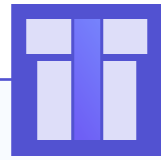

4.4 Employee Care

Kangda International strictly abides by the Labor Contract Law of the People's Republic of China, the Social Insurance Law of the People's Republic of China and other laws and regulations. On the basis of guaranteeing the basic wages of employees, we provide additional performance wages, seniority wages, bonuses, and other benefits, among other competitive remuneration packages. We have formulated the Regulations on Compensation Management of Member Companies (Revised), and continued to strengthen the overall planning of insurance, holiday allowances and other welfare policies, so that the Company's benefits and employee well-being can grow together.

Kangda International calls on managers at all levels to actively listen to the voices of employees. To this end, we have compiled and issued the Management Measures for Employee Complaints and Satisfaction Surveys to collect statistics on employee satisfaction through questionnaire surveys and interviews. We also set up dual channels for clarification and reporting, so that employees can choose either channel according to their needs. We make full use of employee suggestion boxes, emails, hotlines, etc. for employees to give feedback. The internal audit department needs to respond to employees' feedback thoroughly, ensure timely acceptance and independent investigations of each reasonable report based on the principles of authenticity, confidentiality, and effectiveness, and take appropriate follow-up actions on the basis of whistleblower protection.

Kangda International attaches great importance to the happiness and satisfaction of employees at work, and is committed to creating a warm working environment. In 2020, in order to enrich the diversity of employee benefits, we standardized the procurement channels for employee gifts of Kangda member companies and adjusted the Company's heating subsidy standards to protect the basic life rights of employees, translating our care for employees into practical actions.

In addition, we organized diversified cultural and sports activities such as "Celebrating the Chinese New Year" to help employees balance work and life, promote their physical and mental health, and enhance their well-being.



Kangda Employee Care Activities in Shanxian

On the occasion of the Mid-Autumn Festival, the general manager and the chair of the trade union of the Shanxian factory sent sincere greetings and heart-warming condolences to the frontline employees, and brought the Company's holiday greetings and blessings to the employees and their families, so that employees enjoyed the benefits and the care of the Company.



2020 "Celebrating the Chinese New Year" cultural and sports activities

On the eve of the Spring Festival of 2020, in order to enrich the spiritual life of our employees, our project companies in various regions organized a variety of cultural and sports activities, which fully demonstrated the spirit of unity, cooperation, positiveness, and courage of our employees, enhanced the communication between colleagues, achieved the purpose of pooling strength towards common goals.



• Table tennis match



• Singing competition



• 100-meter race



• Award ceremony after the game

ENVIRONMENTAL PROTECTION

Under China's commitment to achieving the goal of "peak emission and carbon neutrality", Kangda International, as an environmental protection company, has always fulfilled its corporate responsibilities and actively responded to national advocacy. While creating clear waters and green mountains for the society, Kangda International reduces consumption through energy conservation, reduces pollution and emissions, and reduces the impact of its own operations on the environment, in order to create a new model of sustainable development for a better living environment.

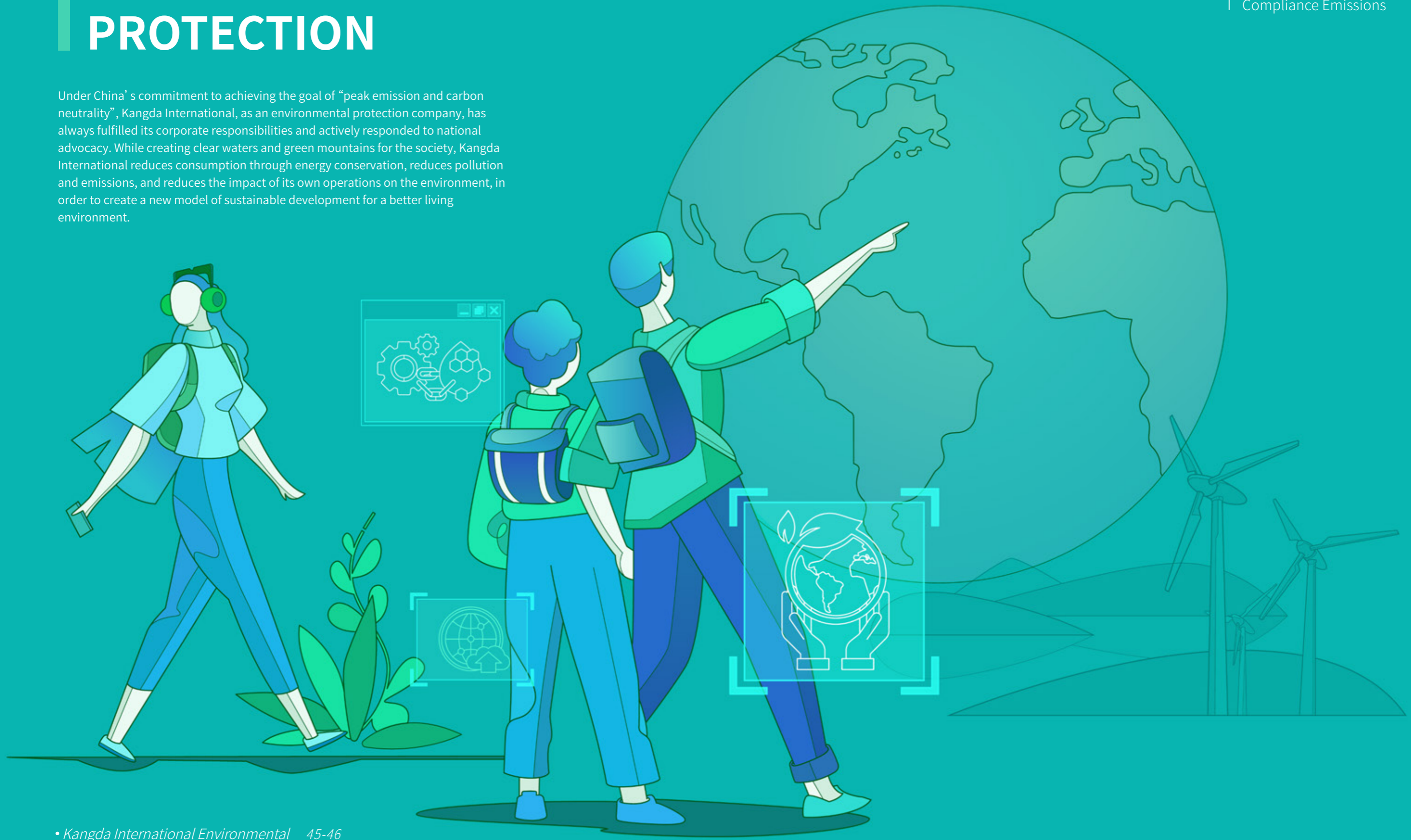

ENVIRONMENTAL PROTECTION



5.1 Green Management

Kangda International continuously improves the environmental management system, advocates the green concept of energy saving and emission reduction, and strictly controls the discharge of various pollutants. We strictly abide by the Environmental Protection Law of the People's Republic of China and other relevant laws and regulations, and by continuously introducing green concepts into project management, we reduce the negative impact on the environment, and contribute to the protection of the ecological environment and the realization of a green circular economy. Chongqing Kangda Environmental Protection Industry (Group) Co., Ltd. has obtained ISO 14001 environmental management system certification.

In accordance with the relevant national regulations, we have formulated the Environmental, Occupational Health and Safety Inspection System and the Environmental Factors, Hazard Source Identification Evaluation Management System. Through a sound system and reasonable methods and measures, we regularly identify environmental risks in the process of project construction and operation, and organize the investigation and management of hidden dangers.

In the process of project construction, we earnestly abide by the Evaluation Standard for Green Construction of Building (GB/T 50640-2010), the Code for Green Construction of Building (GB/T 50905-2014) and other specifications by formulating the "Four Savings and One Environmental Protection" (measures for saving materials, water, energy and land, and environmental protection control) and signing the target-oriented environmental management responsibility letter.

During the reporting period, Kangda International achieved the management goals of no environmental pollution accidents and all pollutant emissions reaching the standards.



● ISO 14001 Environmental Management System Certification



5.2 Low Carbon And Consumption Reduction

Kangda International insists on reducing its own resource and energy consumption and creating a low-carbon operation and lifestyle through reducing greenhouse gas emissions. We strictly abide by the Energy Conservation Law of the People's Republic of China, set the next year's assessment targets based on the annual production indicators, and strictly manage energy and resource consumption. We also dynamically adjust the use of resources and energy according to the daily water quality and actual operating conditions.



Energy consumption

For the operation link, we formulate energy-saving measures based on the annual assessment target-oriented responsibility letter combined with various operating data, online water quality, corresponding technical manual specifications, and related literature materials. In the construction and office links, we reduce indirect energy consumption by optimizing electrical equipment.

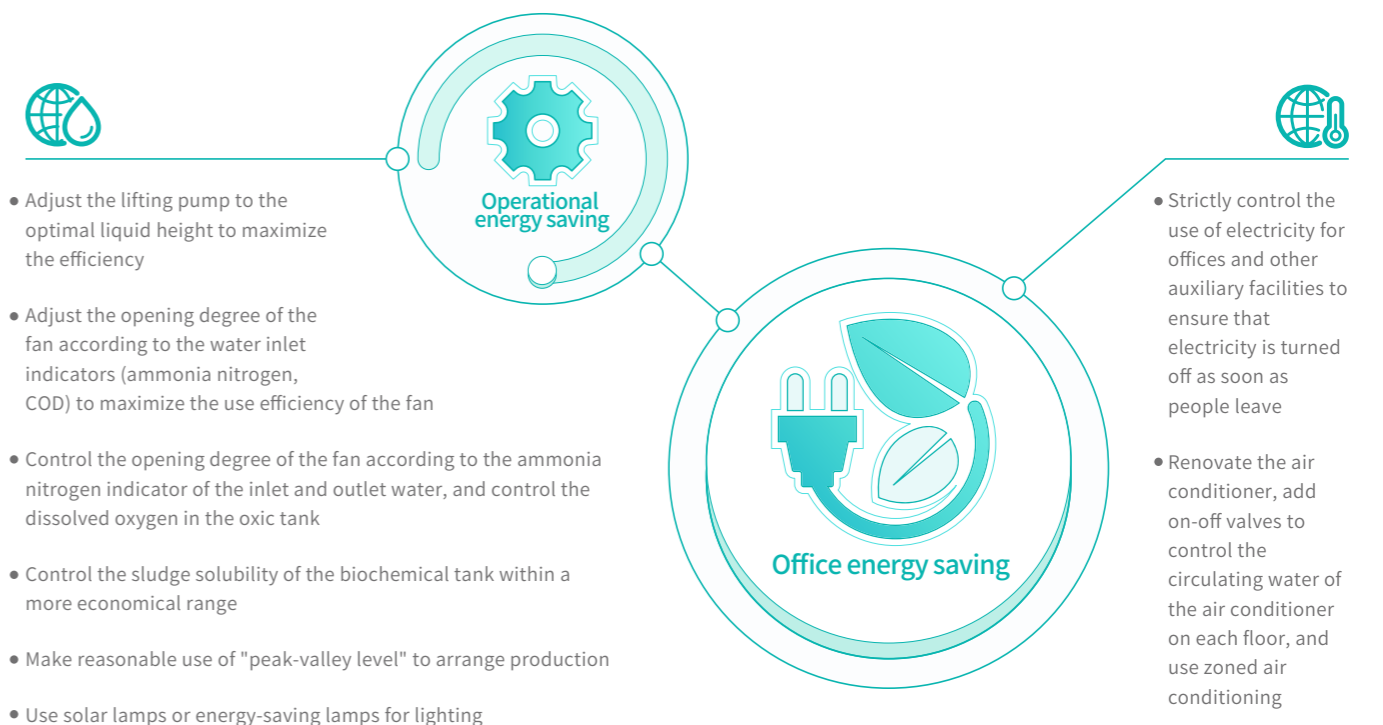

Special training on "Sewage Treatment Plant's Cost Control, Energy Saving and Consumption Reduction"

In order to achieve energy saving and consumption reduction, while reasonably controlling costs, in September 2020, we launched a special training on "Sewage Treatment Plant's Cost Control and Energy Saving and Consumption Reduction". According to the current industry environment and the basic situation of the Company's operations in recent years, we trained each project manager and person in charge on cost control measures and how to save energy and reduce consumption in terms of data analysis, industry reference, and technology updates, which comprehensively improved the energy use efficiency and operational efficiency of the Company's operating projects.

Liftable aeration system

During the reporting period, we significantly improved energy use efficiency and sewage treatment effects through the introduction of a liftable aeration system. The liftable microporous aerator adopts the aeration tube to hold water, integrating it with the water, which solves the problem of buoyancy in the water. The system has the characteristics of uniform aeration, small bubbles, high oxygen utilization rate, and high power efficiency, which can reduce the sludge deposition at the bottom of the tank during aeration, increase the aeration area, increase the oxygenation capacity, and reduce energy consumption. Moreover, the aerator is installed, repaired, and replaced without shutting down the fan, saving switches and energy consumption. Through cost analysis before and after the transformation, it can save up to 100 kWh of electricity per month.

We actively promote market-oriented power transactions. During the reporting period, a total of 35 operating projects under the Company signed market-oriented power purchase contracts, with a total transaction of approximately 180 million kWh.

- During the reporting period, the greenhouse gas emissions generated by our direct energy were reduced by 5%, and the total greenhouse gas emission intensity was reduced by 4%. The energy use and greenhouse gas production are as follows:

Energy Category		2019	2020
Direct energy	Diesel (liter)	123,576	118,330
	Gasoline (liter)	358,444	340,135
	Natural gas (cubic meter)	5,080	3,781
Indirect energy	Outsourcing power (kWh)	356,051,741	382,773,833
Total energy consumption (tons of standard coal)		44,301	47,558
Comprehensive energy consumption density (tons of standard coal/thousand cubic meters)		0.04	0.04

Emission of greenhouse gases

	2019	2020
Greenhouse gas emissions - direct emissions (tons of carbon dioxide equivalent)	1,133	1,076
Greenhouse gas emissions - indirect emissions (tons of carbon dioxide equivalent)	240,687	258,321
Total greenhouse gas emissions (tons of carbon dioxide equivalent)	241,820	259,397
Greenhouse gas emissions per unit of income (tons of carbon dioxide equivalent/ thousand cubic meters)	0.24	0.23

Resource consumption

We strictly control the consumption of resources in the process of office work and project construction and operation. Through measures such as rainwater reuse, paperless office, and high-efficiency chemicals, we reduce the Company's total consumption of water resources, office resources and chemical resources across the value chain.

Water resources

- Use rainwater storage for on-site greening during construction;
- Use water-saving sanitary ware in the toilet;
- Reuse the reclaimed water after production and treatment for plant greening and irrigation, road washing in the plant, etc.;
- Kangda Environmental Qitaihe Water Co., Ltd. actively carries out reclaimed water reuse, saving about 5 million tons of water resources throughout the year;
- Wenzhou Chuangyuan Water Co., Ltd. uses the reclaimed water after production and treatment in the urban municipal lighting project - Water Screen Movie Show.

Office resources

- The office promotes paperless office to save paper;
- Use double-sided printing as much as possible to reduce the consumption of paper materials and the generation of waste paper.

Chemical resources

- Update the "Administrative Measures for the Addition and Use of Chemicals";
- Carry out the exchange and learning activities on "Reducing Chemicals Operation Cost";
- Carry out chemical trials to find efficient and economical chemical agents.

- During the reporting period, our water consumption intensity decreased by 9%, and the consumption of resources and water resources is as follows:

Resource		2019	2020
Construction consumables(tons)		850,765	791,696
Water resources	Total water consumption (10,000 cubic meters)	47	48
	Water intensity (cubic meters/thousand cubic meters)	0.46	0.42
Paper (tons)		2.3	2.5

In addition, we attach great importance to the use of recycled materials in the design process of the project site, requiring the decoration and garden construction to use energy-saving materials such as high-resistance bamboo and anti-corrosion boards and the football field and basketball court of the project site to use recycled plastic particles as much as possible, thereby reducing the waste of resources.



5.3 Compliance Emissions

Kangda International has always practiced a clean production and business model, and strictly manages the generation and treatment of the "four wastes". We strictly comply with the People's Republic of China on the Prevention and Control of Atmospheric Pollution, the Law of the People's Republic of China on the Prevention and Control of Water Pollution, the Law of the People's Republic of China on the Prevention and Control of Solid Waste Pollution, the Law of the People's Republic of China on the Prevention and Control of Environmental Pollution by Solid Wastes, the Law of the People's Republic of China on Prevention and Control of Pollution From Environmental Noise and other applicable laws. And in accordance with the relevant rules, we have formulated the Standard for Safety and Civilization Construction of Construction Sites and Manual for Hazardous Waste Management. We conduct comprehensive and strict management of exhaust gas, waste, and noise in the process of project construction and operation to minimize the impact on the environment. The waste water generated during our daily office work is discharged into municipal pipelines. A small amount of waste water generated during the construction process has been compliantly disposed of. The waste water generated during the operation of each water plant is self-disposed and discharged compliantly.



Exhaust gas management

The main air pollutant produced by Kangda International is particulate matter (dust) during the construction process. We have always adhered to the concept of green and civilized construction, formulated various standardized requirements during project construction, strictly controlled atmospheric and dust pollution, and created a green construction site image. The main dust control measures carried out during the reporting period are as follows:



• Muck coverage in non-rainy season



• Road flushing



• Enclosure with green net



• Wet work

Waste management

Kangda International implements strict waste management. Through waste management and control throughout the whole process of project design, construction and operation, we reduce the amount of waste generated, improve the utilization rate of waste, and reduce the negative impact on the environment. Regarding hazardous waste, we have formulated the Hazardous Waste Management Manual to dispose of it in compliance with relevant requirements.

During the construction of the project, we strip the ground and add environmentally friendly fertilizers for slaking to produce starter fertilizers that can be used later. The remaining earthwork and construction waste will be reused in situ for the construction of temporary access roads, etc., to reduce the amount of construction waste and abandoned earthwork.

In the daily office process, we advocate the use of garbage sorting to better classify, transport and treat garbage. In addition, we reduce the generation of kitchen waste and the disposal of waste by optimizing the dining method, accurately planning the number of people to eat, and using the buffet style.

- During the reporting period, the intensity of sludge production decreased by 13%, and our emissions are as follows:

Solid Waste	2019	2020
Sludge production (tons) Note: The moisture content of sludge is about 75%	991,568	953,239
Intensity of sludge generation (ton/thousand cubic meters)	0.96	0.84
Household waste generation (tons)	12	206★

Noise management

In order to reduce the impact of noise during the construction process, we strictly implement noise control in accordance with relevant requirements, eliminate machinery that produces louder noise, and strictly follow the construction timetable for construction. In case of tight schedules and rush work periods, we require all mechanical operations to be stopped after eight o'clock in the evening; all operation personnel in the project department, slag trucks and excavators to stop related operations after ten o'clock in the evening.

★ The data in 2020 include the amount of kitchen waste.

COMMUNITY ENGAGEMENT

China has a saying, "When drinking water, we should think of its source." It implies the social responsibility of private entrepreneurs. While carrying out the corporate vision of "being the pioneer in the environmental protection industry and creating a century enterprise", Kangda International actively assumes corporate responsibilities in the two areas of environmental protection and charity and philanthropy to contribute to society. The Company continuously upgrades "green technology" and project advantages, and builds greener homes through work in areas such as urban water treatment, water environment comprehensive remediation, and rural sewage treatment. We are also committed to strengthening communication with the community, building a beautiful home together, and raising the public's attention to environmental protection through projects such as charitable environmental protection education and environmental protection activities.

"Green" Co-construction
Philanthropy



COMMUNITY ENGAGEMENT



6.1 "Green" Co-construction

Lucid waters and lush mountains are invaluable assets. Kangda International adheres to the corporate mission of "making water clearer, mountains greener, and skies bluer", strictly abides by the water quality requirements, and actively explores new technologies and new channels for environmental pollution control. The Company conducts environmental governance around the three business sectors of urban water treatment, water environment comprehensive remediation and rural sewage treatment. We firmly grasp the opportunities of environmental industry transformation and reform, strive to explore the new ecology of the environmental industry, and spare no effort to promote green ecological development and build harmonious ecologically civilized cities with technical expertise and high-quality services.

• Overview of "green" co-construction this year:



A total of **112** service franchise projects, **105** sewage treatment plants, **2** water supply plants, **3** sludge treatment plants, and **2** reclaimed water plants



93 sewage treatment projects in operation, with the current sewage treatment capacity of **3.767** million tons/day

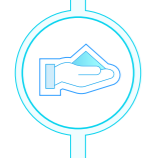

3 sludge treatment projects with a total treatment capacity of **550** tons/day, and **2** reclaimed water projects with a total treatment capacity of **65,000** tons/day



3 rural sewage treatment projects

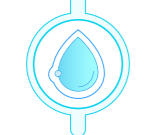

15 water environment comprehensive remediation projects, **14** of which are under construction

Environmental performance of this year



The total treated water volume reached **1,133.6** million tons, an increase of **10%** from 2019. Among them, the sewage treatment service treated **1,129.3** million tons, and the reclaimed water treatment service treated **4.3** million tons.



COD treatment **260,000** tons



Ammonia nitrogen treatment **31,000** tons



Total phosphorus treatment **5,066** tons



Sludge disposal **950,000** tons

Speeding up urban and rural water service construction and protecting the lucid waters and green mountains

Water is the source of life, the essential of production, and the foundation of ecology. However, problems such as the treatment of water pollution and the maintenance of the water eco-environment have become important issues in the environmental protection industry. Kangda International takes as its main tasks strengthening sewage discharge management, upgrading and improving sewage treatment facilities, and improving sewage treatment standards and capabilities, while ensuring "sewage-clean water conversion" through measures such as strengthening management support and increasing scientific and technological investment. In this way, we give back to nature's water resources with the cleanest effluent, and protect rivers, lakes and seas.

• Taiyuan Fendong Sewage Treatment Plant Phase I Project

In order to solve the problem of full collection and full treatment of sewage in the area south of Taiyuan's southern ring transit expressway and east of the Fen River in Taiyuan, in accordance with Chairman Xi's requirement of "improving the water quality, quantity and scenery of Fen River" during his inspection in Fen River of Shanxi in 2017, Kangda International - as the project implementation unit - started to undertake the first phase of the Taiyuan Fendong Sewage Treatment Plant.



The project covers an area of 13.71 hectares with an above-ground layout and a design scale of 350,000 tons per day. The scope of service includes the area within the Taiyuan city boundary east of Fendong and south of the southern ring transit expressway.

The Company implemented two steps in accordance with the drainage planning and construction status of Taiyuan City. The first step measures 150,000 tons/day, using AAO+NCE+ advanced treatment technology, with a total investment of about RMB 440 million. Construction started at the end of 2017 and was completed for use on December 29, 2018. The second step measures 200,000 tons/day, using MBR sewage treatment technology, with a total investment of about RMB 656 million. It was officially put into operation on May 15, 2020, fully discharged water on June 15, 2020 with the quality of the effluent reaching the design requirements.

The project after completion plays a huge role in the complete collection and complete treatment of domestic sewage in the southern area of Taiyuan City and in the compliance of the water quality of the Wennanshe National Surface Water Assessment Section of the Taiyuan Section of the Fen River Basin, laying a solid foundation for integrated advancement of "governance of water, mountains, air and cities" and "reproduction of the splendid grand scene in Taiyuan City".

• **Completion and acceptance of five township sewage plants in Jiaoling County**

On August 7, 2020, Kangda International completed the acceptance of five town-level sewage plants and supporting pipe networks in Jiaoling County, and successfully passed the three-month water quality monitoring assessment by a third-party testing agency. The construction of the five town-level sewage plants will speed up the pace of village-level infrastructure construction. By introducing municipal facilities into the countryside, we jointly build beautiful villages and towns.



• **Qicheng Sewage Treatment Plant Standard Upgrading and Reconstruction Project**

The Qicheng Sewage Treatment Plant's upgrading and renovation project has a design scale of 100,000 m³/day. After the upgrading and renovation, the effluent standard will be upgraded from Class 1 A to Class 4 surface water standard. The project investment is RMB 160 million. After the completion of the project, the quality of the effluent from the sewage plant will be greatly improved and the surrounding ecological environment will be improved.



• **Leping Project**

The PPP comprehensive treatment project of the South Inland River in Leping City aims at "smooth rivers, clear waters, green shores and beautiful sceneries". The works include endogenous treatment, clean water replenishment, source control and pollution interception, ecological restoration, sponge city renovation, etc.



• **Dandong New District Sewage Treatment Plant Phase I Project**

Dandong New District Sewage treatment Project Phase I project is located in the Equipment Manufacturing Park of Dandong New District. The total investment is about RMB 100 million. According to the construction plan by 2030, the total design scale is 370,000 m³/day, and the total planned land-use area is about 25 hectares. The sewage discharge of the factory meets the "Class A" standard stipulated in the current national Emission Standard for Pollutants for Urban Sewage Treatment Plants (GB 18918-2002). The sewage treatment scale of Phase I (first stage) of the Dandong New District Sewage Treatment Plant is 2m³/d. The commissioning was completed on July 24, 2020, the environmental protection acceptance announcement was completed on December 8, 2020, and the commercial operation was confirmed on December 15, 2020. According to the plan of the feasibility study report, the treatment scale of the Phase I (first stage) is 2m³/d, and will reach 4m³/d on second stage, 7m³/d on third stage. It will treat nearly 370,000 cubic meters of sewage per day for the surrounding municipal pipe network, providing a solid guarantee for people's livelihood.



Promoting comprehensive management of wetlands and maintaining green ecology

Green development is an inevitable requirement for the construction of ecological civilization. Kangda International actively responds to the national requirements and advocacy related to the comprehensive management of the water environment, adheres to the development concept of "innovation, coordination, greenness, openness, and sharing", and takes into account economic development and ecological construction to restore the functions and landscapes of the water environment of rivers and wetlands, promote the high-quality development of the enterprise, advance the comprehensive management of regional rivers, wetlands and other water ecological environment, and drive urban development.

Fuzhou Sanjiang Wetland Ecological Restoration Project

As an important ecological project of "recovering the clean water of the Fuhe River", the Sanjiang Wetland Project transforms Fuzhou's resource advantages into industrial advantages and promotes the development of an eco-tourism economy. It is a demonstration project for the achievements of the first phase of the comprehensive management of the Fuhe River Basin.



The Sanjiang Wetland Ecological Restoration Project covers a total area of about 92.53 hectares, with a total investment of RMB 230 million. The project includes landscape engineering, water conservancy engineering, municipal transportation and bridge engineering, water ecological engineering, early warning system, etc. Taking natural ecology as the base, water resources as the carrier, ecological protection as the core, and harmonious coexistence between man and nature as the lead, it is an integrated wetland ecological restoration project with theme tourism bases featuring lawns, lotus ponds, wetlands, meadows, and beaches as the main line, supplemented by multiple functions such as wetland restoration, water purification, bird habitat, and citizen leisure.



During the reporting period, the Sanjiang Wetland Project was fully completed. For ecological restoration, by relocation, it retained the original ecological base and repaired the damaged ecological environment; by cleaning, it restored water ecology and purified sewage; by combing and adapting to local conditions, it dredged the water system with rational earthwork digging and filling; for prevention, by adapting to local conditions, it made a rational layout for layered flood prevention to ensure the safety of flood discharge; by repairing, it respected the original appearance of nature and embodied the "large-scale, natural, and broad" ecosystem. The Sanjiang Wetland Project after completion undertakes the task of disposing of tail water and sewage in the urban area of the Fuhe River Basin and effectively resettling the residents of villages and shanty towns threatened by floods. It is a livelihood project to promote local re-employment. After the project is completed, it will become a water tourism route connecting Menghu Lake and Fuhe River in Fuzhou City, and will together with Menghu Lake create a national 5A wetland park. As the contractor of the project, Kangda International will always adhere to the corporate policy of "water-oriented contribution to society" and make greater contributions to the construction of the ecological environment of the Sanjiang Wetland.



6.2 Philanthropy

Kangda International practices its core values of "integrity and responsibility, and give back to society", Kangda International contributes to social development through practical actions. We have been working on public welfare and charity activities including supporting education, community caring, and fighting against the COVID-19 epidemic, etc. We commit to striving for social development with the joint hands of stakeholders who share the same warmth and love to society.



Environmental education

Public opening of environmental protection is an important part of public participation their participation. With focusing on water affairs, Kangda International is committed to corporate social responsibilities. We strongly believe that protecting our environment and winning blue sky protection battle can be only achieved through the participation of all.

Teachers and students of Shangqiu University visited Kangda environmental protection (Shangqiu) water Co., Ltd

Kangda Environmental Protection (Shangqiu) Water Co., Ltd., a subsidiary of Kangda International, is a unit of "Environmental Protection Facilities and Wastewater Treatment Facilities Open to the Public" awarded by the Ministry of Housing and Urban-rural Development and Ministry of Environmental Protection, and the Education Base of Henan Province Environmental Protection Department and Shangqiu City Environmental Protection Department.



In order to help the public further understand, pay attention to, support and participate in environmental protection, in the morning of October 29, 2020, 50 teachers and students of major in Geographic Surveying, Mapping and planning of Shangqiu Institute went to Kangda Environmental Protection (Shangqiu) Water Co., Ltd. for an on-site visit. Through factory staff's elaboration of process flow and treatment principle of each stage, they have learnt the whole process of turning black and stink domestic sewage to clean water.

Interest activity group of Qishan County Shanjiu school visit Qishan factory

In the afternoon of October 10, 2020, more than 50 teachers and students from the junior high school of Shanjiu School of Qishan County came to Qishan Dayuan Sewage Treatment Co., Ltd. to learn the whole process of urban sewage treatment, as well as the central control room, laboratory and main equipment functions. From the on-site staff's detailed explanation of the whole process from water inlet to water outlet, the visiting teachers and students have a preliminary understanding of sewage treatment, so as to understand how to protect water resources and save water, apply the idea of loving, cherishing, protecting and saving water in their daily life.



Community care

Kangda International have been dedicating to community care activities, in spirit of giving back to the society with concrete actions, to enhance people's sense of gain, happiness and security.

Flood disaster rescue and relief of Leping project

In 2020, the management of Leping project site actively helped the local villagers to fight against floods. The rescue action received high praise from Leping Bureau of Housing and Urban Rural Development.



Fight COVID-19 epidemic

In 2020, COVID 19 epidemic outbreak throughout the country and even the whole world. As a responsible leading company in the environmental protection industry, Kangda International worked at the forefront of epidemic prevention and control. Every Kangda employee, bearing occupational ethic in mind, strive to fulfill the mission of protecting local water and soil, and cleaning a mountain and river.

Hand in hand fighting against COVID-19 epidemic, safeguarding lives

Since the outbreak of COVID-19 epidemic, Kangda International has been putting epidemic affected people first. When Chongqing and Xiaogan City in Hubei province became counterpart cities, Kangda International took positive action at first place.



On February 11, 2020, Kangda International got in touch with Xiaogan Municipal government and Xiaogan Charity Association, when there was extremely lack of epidemic prevention materials, Kangda International actively purchased the supply of goods and donated more than 100,000 masks to Xiaogan people through Xiaogan Charity Association.

APPENDIX

Content Index of the Environmental, Social and Governance Reporting Guide of the Hong Kong Stock Exchange

Subject Areas, Aspects, General Disclosures and KPIs		Page
A.Environmental		
Aspect A1: Emissions		
General Disclosure	Information on: (a) the policies; and (b) compliance with relevant laws and regulations that have a significant impact on the issuer relating to air and greenhouse gas emissions, discharges into water and land, and generation of hazardous and non-hazardous waste.	P48-50 P51-52
KPI A1.1	The types of emissions and respective emissions data.	P52
KPI A1.2	Greenhouse gas emissions in total (in tonnes) and, where appropriate, intensity (e.g. per unit of production volume, per facility).	P50
KPI A1.3	Total hazardous waste produced (in tonnes) and, where appropriate, intensity (e.g. per unit of production volume, per facility).	P52
KPI A1.4	Total non-hazardous waste produced (in tonnes) and, where appropriate, intensity (e.g. per unit of production volume, per facility).	P52
KPI A1.5	Description of measures to mitigate emissions and results achieved.	P51-52
KPI A1.6	Description of how hazardous and non-hazardous wastes are handled, reduction initiatives and results achieved.	P52
Aspect A2: Use of Resources		
General Disclosure	Policies on the efficient use of resources, including energy, water and other raw materials.	P48-50
KPI A2.1	Direct and/or indirect energy consumption by type (e.g. electricity, gas or oil) in total (kWh in '000s) and intensity (e.g. per unit of production volume, per facility).	P49
KPI A2.2	Water consumption in total and intensity (e.g. per unit of production volume, per facility).	P50
KPI A2.3	Description of energy use efficiency initiatives and results achieved.	P48-49

KPI A2.4	Description of whether there is any issue in sourcing water that is fit for purpose, water efficiency initiatives and results achieved.	No issue in sourcing water
KPI A2.5	Total packaging material used for finished products (in tonnes) and, if applicable, with reference to per unit produced.	Not applicable, the product does not involve Packaging materials
Aspect A3: The Environment and Natural Resources		
General Disclosure	Policies on minimizing the issuer's significant impact on the environment and natural resources.	P47
KPI A3.1	Description of the significant impacts of activities on the environment and natural resources and the actions taken to manage them.	P47-52
B.Social		
Employment and Labour Practices		
Aspect B1: Employment		
General Disclosure	Information on: (a) the policies; and (b) compliance with relevant laws and regulations that have a significant impact on the issuer relating to compensation and dismissal, recruitment and promotion, working hours, rest periods, equal opportunity, diversity, anti-discrimination, and other benefits and welfare.	P33-44
KPI B1.1	Total workforce by gender, employment type, age group and geographical region.	P35
KPI B1.2	Employee turnover rate by gender, age group and geographical region.	P36
Aspect B2: Health and Safety		
General Disclosure	Information on: (a) the policies; and (b) compliance with relevant laws and regulations that have a significant impact on the issuer relating to providing a safe working environment and protecting employees from occupational hazards.	P39-42
KPI B2.1	Number and rate of work-related fatalities.	P41
KPI B2.2	Lost days due to work injury.	P41
KPI B2.3	Description of occupational health and safety measures adopted, how they are implemented and monitored.	P41-42

Aspect B3: Development and Training		
General Disclosure	Policies on improving employees' knowledge and skills for discharging duties at work. Description of training activities.	P37-38
KPI B3.1	The percentage of employees trained by gender and employee category (e.g. senior management, middle management).	Will disclose in the future
KPI B3.2	The average training hours completed per employee by gender and employee category.	P38
Aspect B4: Labour Standards		
General Disclosure	Information on: (a) the policies; and (b) compliance with relevant laws and regulations that have a significant impact on the issuer relating to preventing child and forced labour.	P35-36
KPI B4.1	Description of measures to review employment practices to avoid child and forced labour.	P35-36
KPI B4.2	Description of steps taken to eliminate such practices when discovered.	No violations

Operating Practices

Aspect B5: Supply Chain Management		
General Disclosure	Policies on managing environmental and social risks of the supply chain.	P27-30
KPI B5.1	Number of suppliers by geographical region.	P28-29
KPI B5.2	Description of practices relating to engaging suppliers, number of suppliers where the practices are being implemented, how they are implemented and monitored.	P28-29
Aspect B6: Product Responsibility		
General Disclosure	Information on: (a) the policies; and (b) compliance with relevant laws and regulations that have a significant impact on the issuer relating to health and safety, advertising, labelling and privacy matters relating to products and services provided and methods of redress.	P21-24
KPI B6.1	Percentage of total products sold or shipped subject to recalls for safety and health reasons.	No product recalled for safety and health reasons
KPI B6.2	Number of products and service related complaints received and how they are dealt with.	No customer complaints

KPI B6.3	Description of practices relating to observing and protecting intellectual property rights.	P26
KPI B6.4	Description of quality assurance process and recall procedures.	P21-24
KPI B6.5	Description of consumer data protection and privacy policies, how they are implemented and monitored.	Not applicable, we do not require privacy data from consumers
Aspect B7: Anti-corruption		
General Disclosure	Information on: (a) the policies; and (b) compliance with relevant laws and regulations that have a significant impact on the issuer relating to bribery, extortion, fraud and money laundering.	P17-18
KPI B7.1	Number of concluded legal cases regarding corrupt practices brought against the issuer or its employees during the reporting period and the outcomes of the cases.	P17
KPI B7.2	Description of preventive measures and whistle-blowing procedures, how they are implemented and monitored.	P17-18

Community

Aspect B8: Community Investment		
General Disclosure	Policies on community engagement to understand the needs of the communities where the issuer operates and to ensure its activities take into consideration the communities' interests.	P53-60
KPI B8.1	Focus areas of contribution (e.g. education, environmental concerns, labour needs, health, culture, sport).	P53-60
KPI B8.2	Resources contributed (e.g. money or time) to the focus area.	Will disclose in the future